



FUNDAMENTALS OF DATACENTER

Module 1 **Data Center Architecture**

Yogesh Ghorpade
Academician | Trainer | Expert

Data Center Definition

Datacenter Definition

- ❖ A **data center** (sometimes spelled **datacenter**) is a **centralized repository**, either physical or virtual, for the storage, management, and dissemination of data and information organized around a particular body of knowledge or pertaining to a particular business.[1]
- ❖ A **datacenter** is a facility used to house computer systems and associated components, such as telecommunications and storage systems. It generally includes redundant or backup power supplies, redundant data communications connections, environmental controls (e.g., air conditioning, fire suppression) and various security devices. Large data centers are industrial scale operations using as much electricity as a small town.[2]

Datacenter Definition

- ❖ A data center, or datacenter, often requires extensive redundant or backup power supply systems, cooling systems, redundant networking connections and policy-based security systems for running the enterprise's core applications.[3]
- ❖ **Data center management** involves ensuring the reliability of both the connections to the data center as well as the mission-critical information contained within the data center's storage. It also entails efficiently placing application workloads on the most cost-effective compute resource available.[3]

Questions

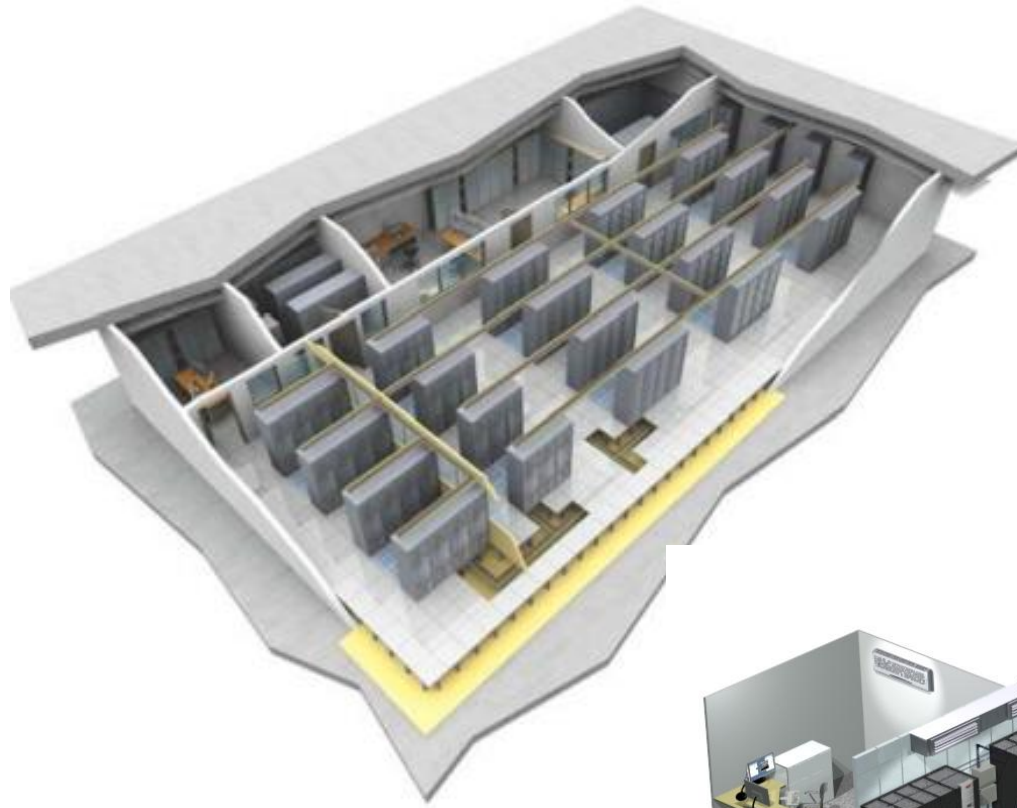

Label the Diagrams

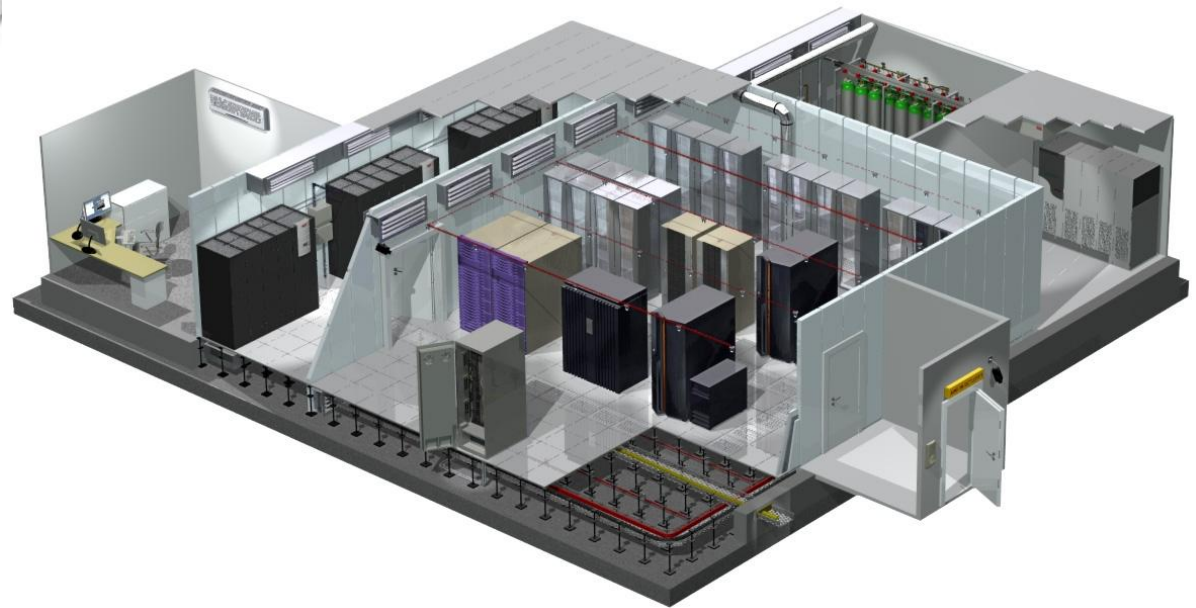

[Watch Video](#)

DataCenter Components with Layout



REFERENCE DESIGN 23
PERFORMANCE-OPTIMIZED 1MW E-CLASS DATA CENTER

OVERVIEW

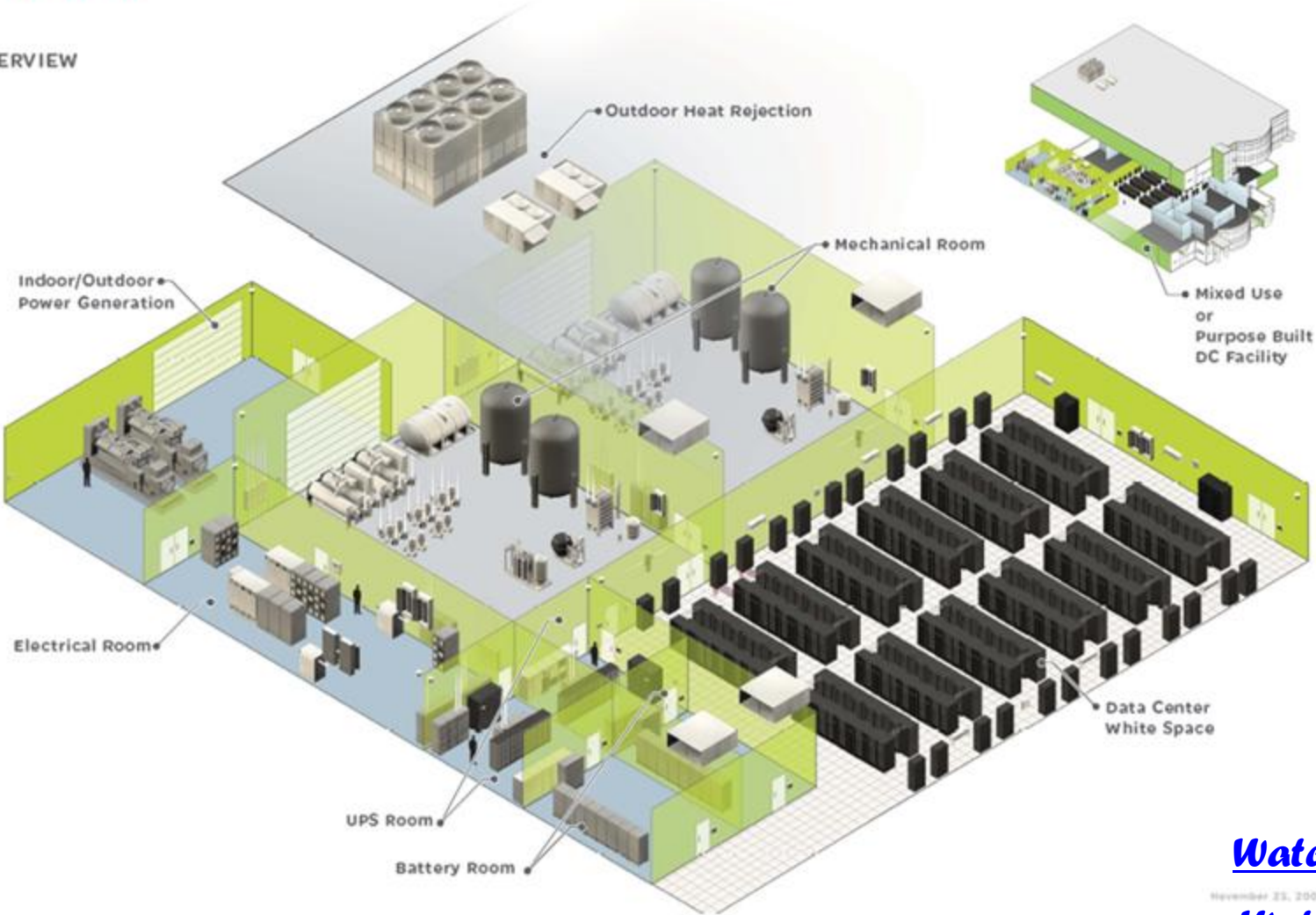

[Watch Video](#)

November 23, 2009

[Watch Video](#)

DataCenter Components with Layout

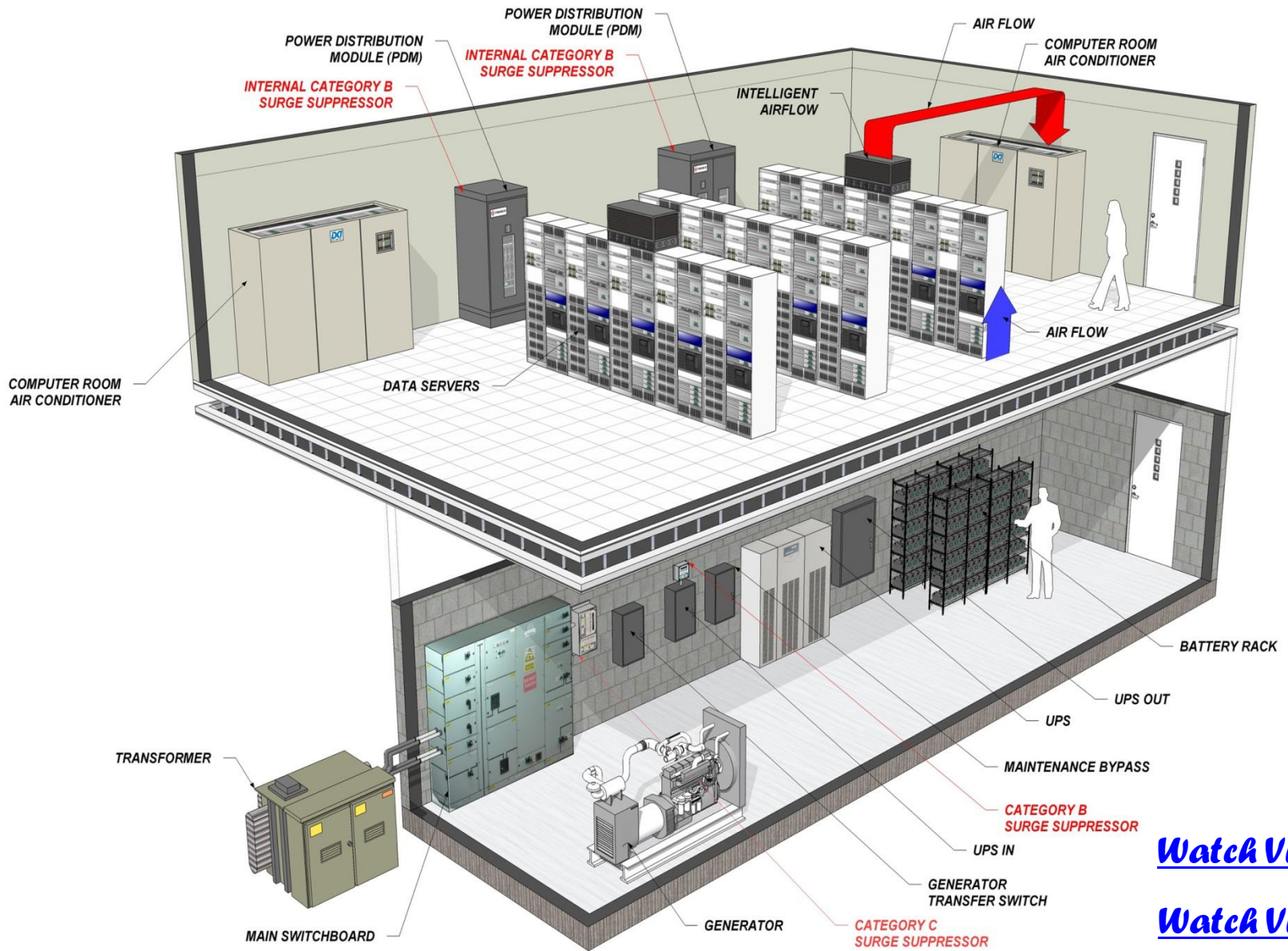

[Watch Video](#)

[Watch Video](#)

DataCenter Components with Layout

SynapSense Solution Overview

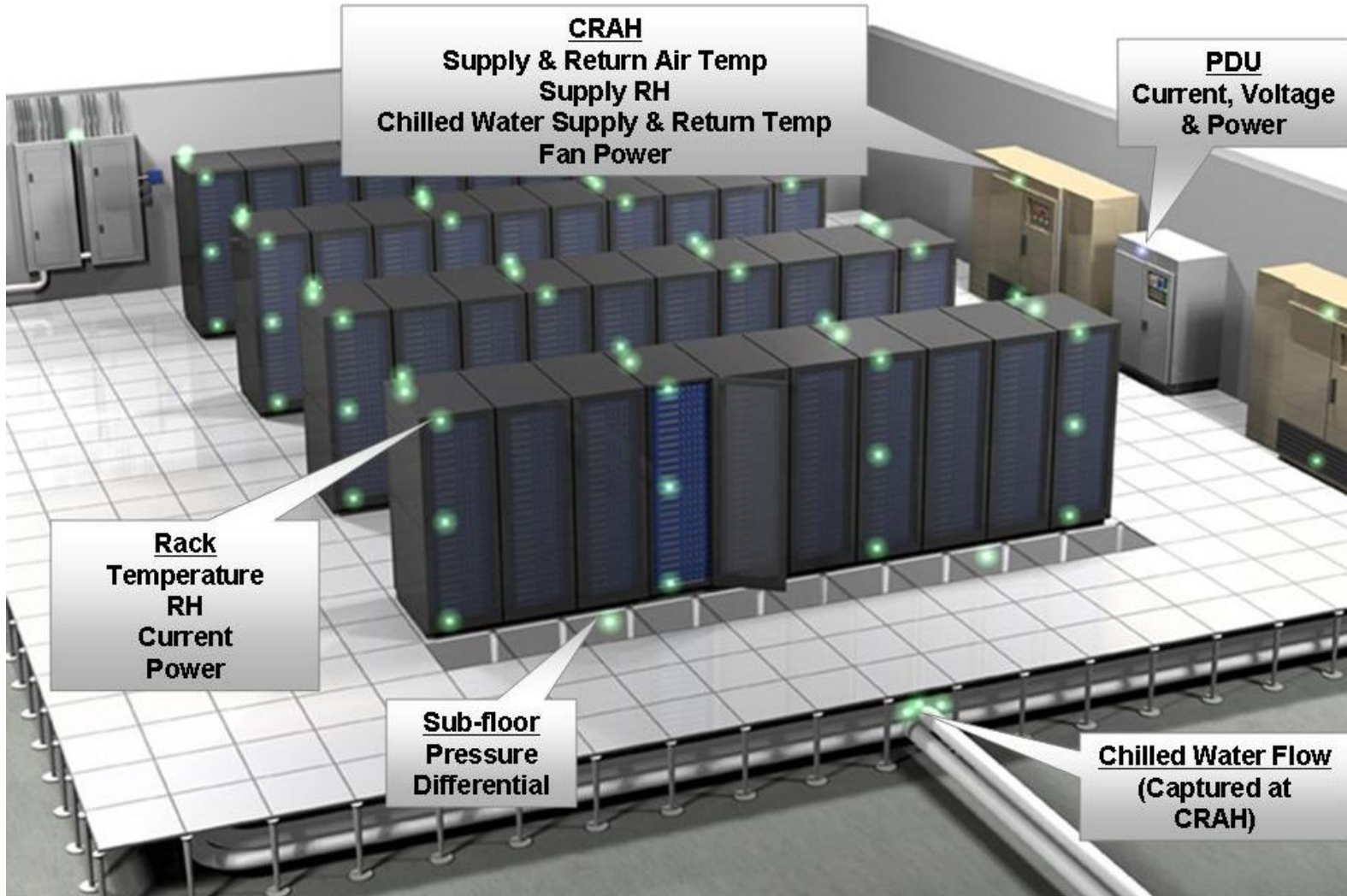

[Watch Video](#)

Data Center Goals

Business goals generate a number of information technology (IT) initiatives:

- Business continuance
- Increased security in the Data Center
- Application, server, and Data Center consolidation
- Integration of applications whether client/server and multitier (n-tier), or web services-related applications
- Storage consolidation. [4]

Data Center Goals

These IT initiatives are a combination of the need to address short-term problems and establishing a long-term strategic direction, all of which require an architectural approach to avoid unnecessary instability if the Data Center network is not flexible enough to accommodate future changes.

The design criteria are

- Availability
- Scalability
- Security
- Performance
- Manageability. [4]

Data Center Goals

These design criteria are applied to these distinct functional areas of a Data Center network:

- **Infrastructure services**—Routing, switching, and server-farm architecture
- **Application services**—Load balancing, Secure Socket Layer (SSL) offloading, and caching
- **Security services**—Packet filtering and inspection, intrusion detection, and intrusion prevention
- **Storage services**—SAN architecture, Fibre Channel switching, backup, and archival
- **Business continuance**—SAN extension, site selection, and Data Center interconnectivity. [4]

Data Center Facilities

These facilities are likely to support a high concentration of server resources and network infrastructure.

The demands posed by these resources, coupled with the business criticality of the applications [4], create the need to address the following areas:

- Power capacity
- Cooling capacity
- Cabling
- Temperature and humidity controls
- Fire and smoke systems
- Physical security: restricted access and surveillance systems
- Rack space and raised floors.

Roles of Data Centers in the Enterprise- Diagram

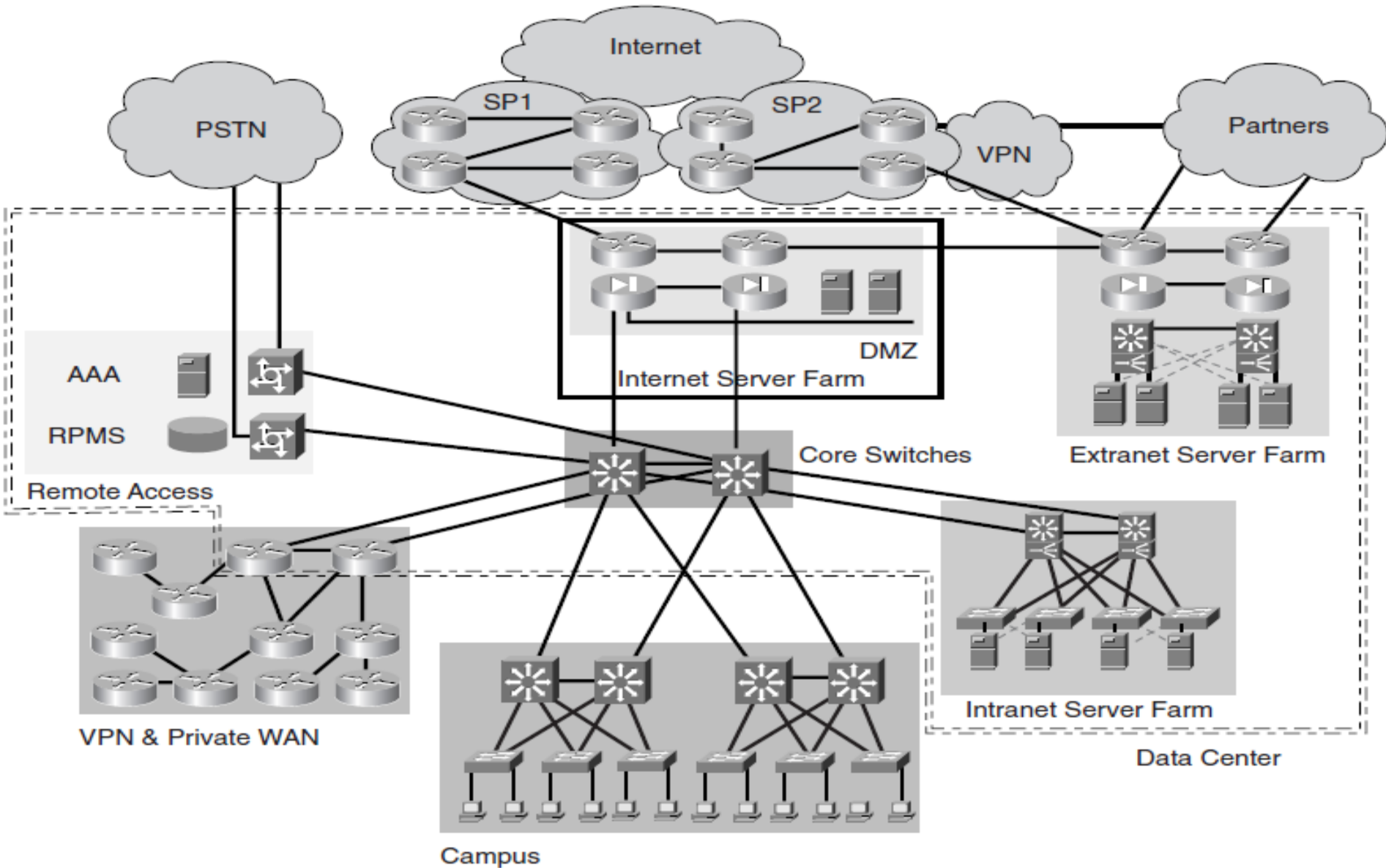

Roles of Data Centers in the Enterprise- Blocks

The building blocks of this typical enterprise network include

- Campus network
- Private WAN
- Remote access
- Internet server farm
- Extranet server farm
- Intranet server farm

Roles of Data Centers in the Enterprise- Application

Enterprise applications typically focus on one of the following major business areas:

- Customer relationship management (CRM)
- Enterprise resource planning (ERP)
- Supply chain management (SCM)
- Sales force automation (SFA)
- Order processing
- E-commerce

Roles of Data Centers in the Service Provider Environment

- Data Centers in service provider (SP) environments, known as Internet Data Centers (IDCs), unlike in enterprise environments, are the source of revenue that supports collocated server farms for enterprise customers.
- The SP Data Center is a service-oriented environment built to house, or *host*, an enterprise customer's application environment under tightly controlled SLAs for uptime and availability.
- Enterprises also build IDCs when the sole reason for the Data Center is to support Internet-facing applications.

Roles of Data Centers in the Service Provider Environment

- The IDCs are separated from the SP internal Data Centers that support the internal business applications environments.
- Whether built for internal facing or collocated applications, application environments follow specific application architectural models such as the classic client/server or the n-tier model. [4]

Application Architecture Models

- Application architectures are constantly evolving, adapting to new requirements, and using new technologies.
- The most pervasive models are the client/server and n-tier models that refer to how applications use the functional elements of communication exchange.
- The client/server model, in fact, has evolved to the n-tier model, which most enterprise software application vendors currently use in application architectures.
- This section introduces both models and the evolutionary steps from client/server to the n-tier model. [4]

The Client/Server Model and Its Evolution

The classic client/server model describes the communication between an application and a user through the use of a server and a client. The classic client/server model consists of the following:

- A thick client that provides a graphical user interface (GUI) on top of an application or business logic where some processing occurs.
- A server where the remaining business logic resides.

Client/Server and n-Tier Application Interaction

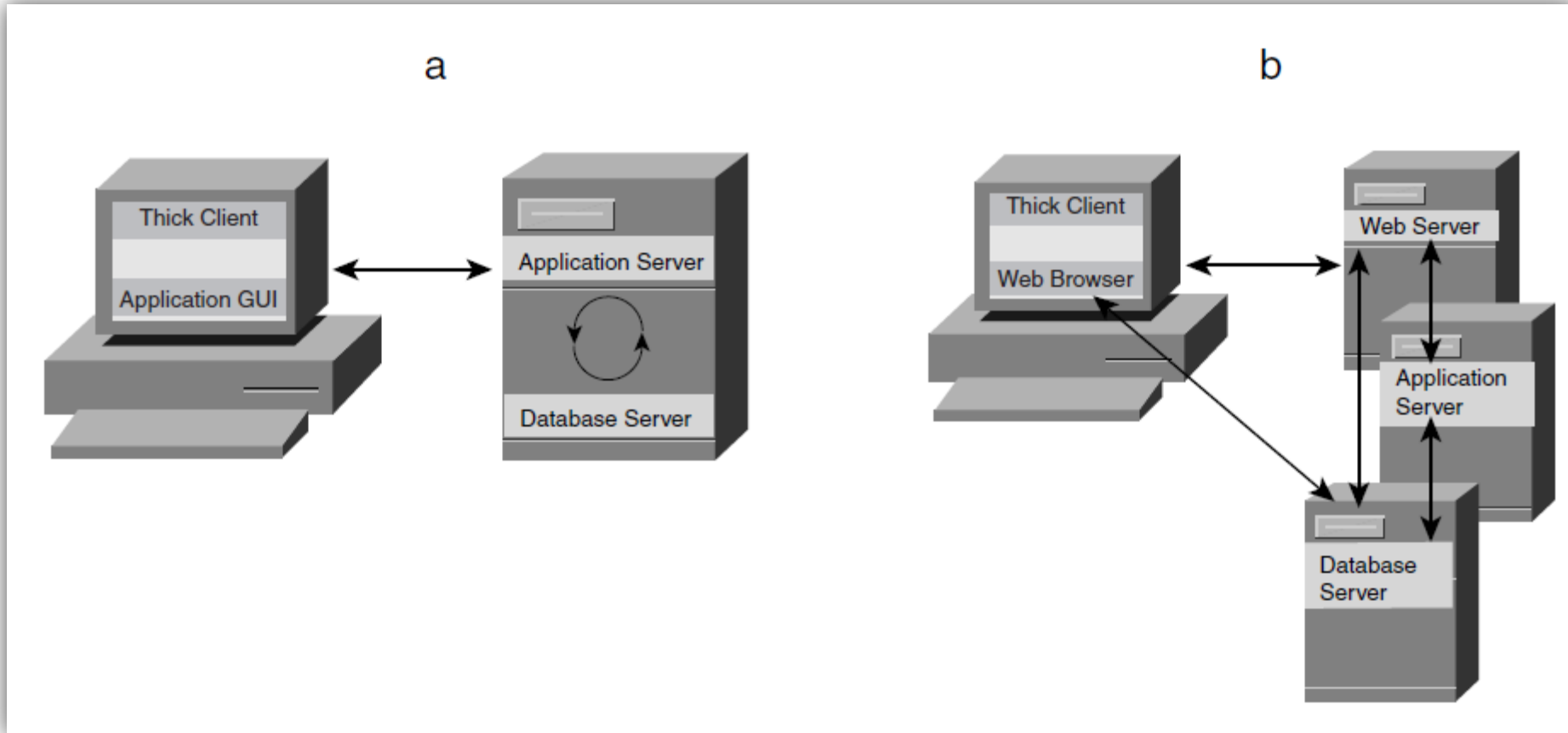
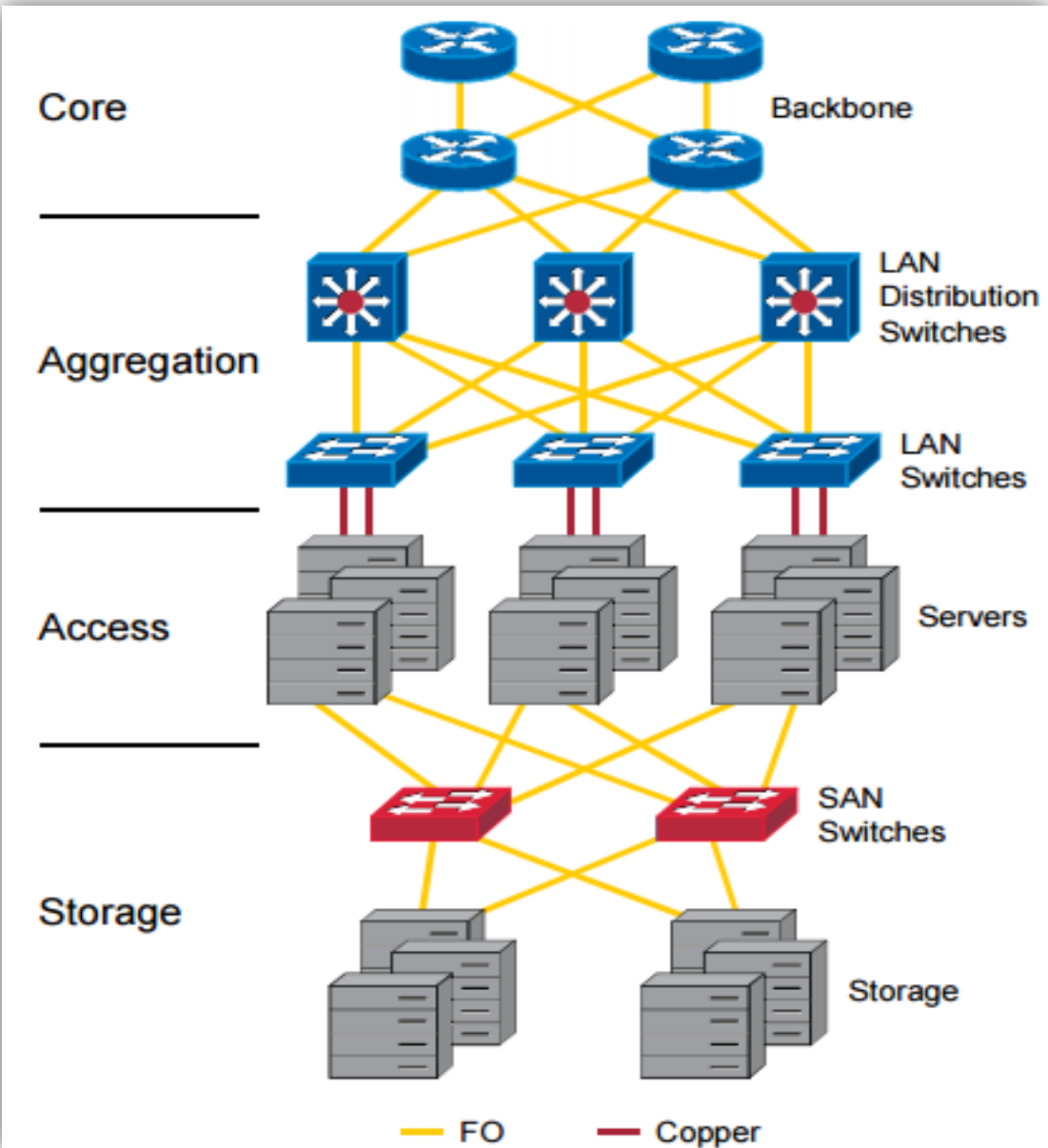

Fig. Client/Server and n-Tier Application Interaction [4]

Three Tier Network



The n-Tier Model

- The n-tier model uses a thin client and a web browser to access the data in many different ways.
- The server side of the n-tier model is divided into distinct functional areas that include the web, application, and database servers.
- The n-tier model relies on a standard web architecture where the web browser formats and presents the information received from the web server.

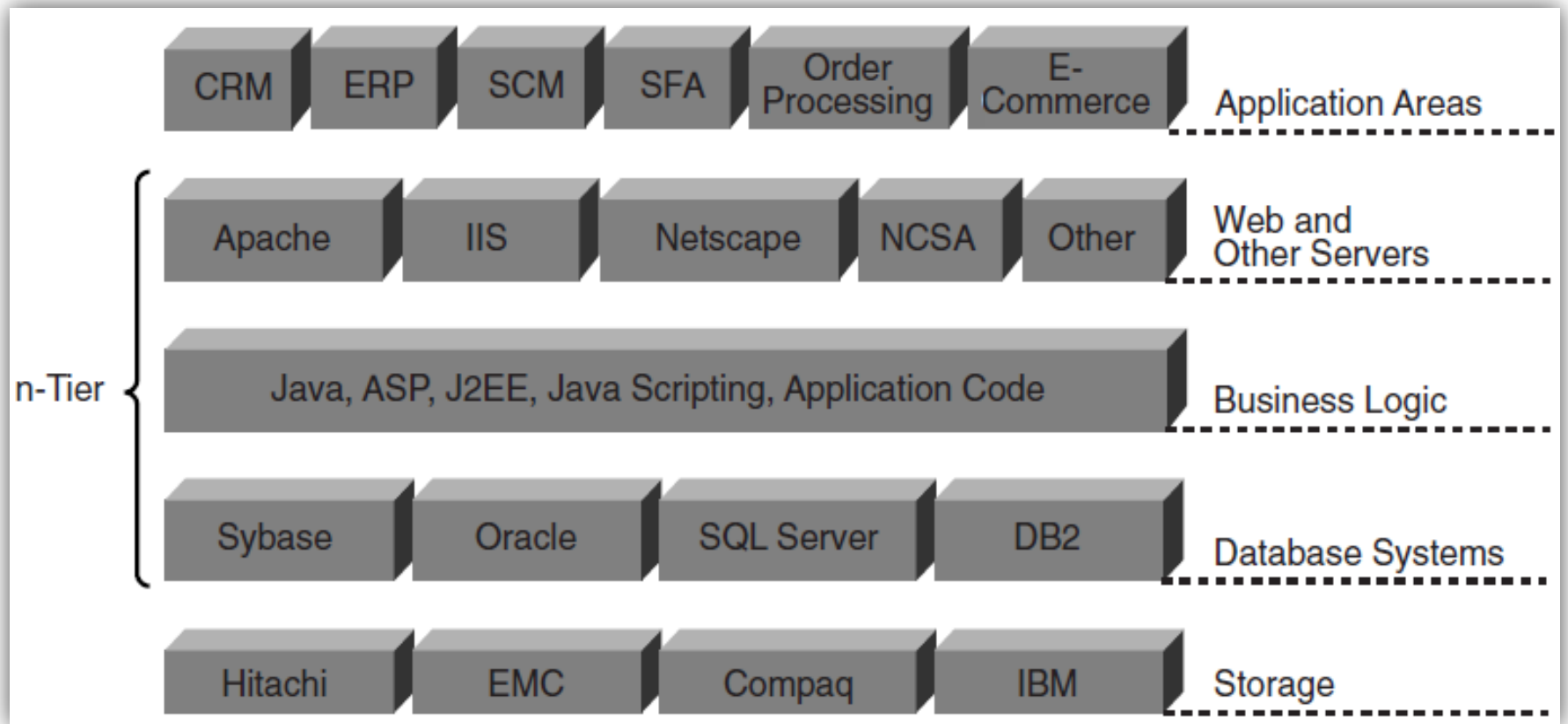

Fig. n- Tier Model [4]

Multitier Architecture Application Environment

- Multitier architectures refer to the Data Center server farms supporting applications that provide a logical and physical separation between various application functions, such as web, application, and database (n-tier model).
- The network architecture is then dictated by the requirements of applications in use and their specific availability, scalability, and security and management goals.
- For each server-side tier, there is a one-to-one mapping to a network segment that supports the specific application function and its requirements. Because the resulting network segments are closely aligned with the tiered applications, they are described in reference to the different application tiers.

Multitier Network Segments

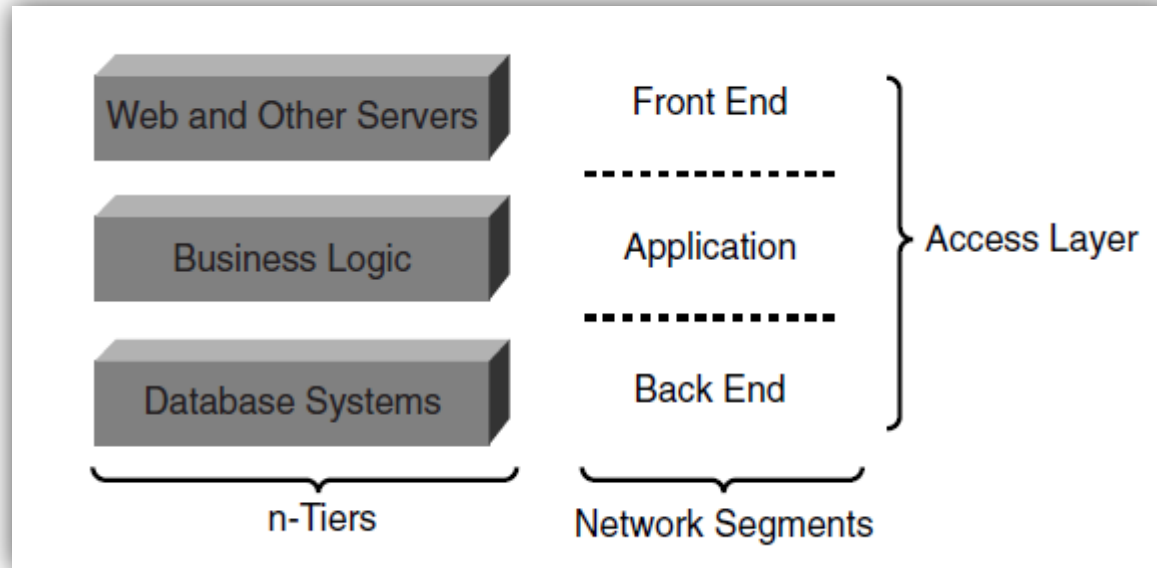

Fig. Multitier Network Segments [4]

- In the Fig. The web server tier is mapped to the front-end segment, the business logic to the application segment, and the database tier to the back-end segment.
- Notice that all the segments supporting the server farm connect to access layer switches, which in a multitier architecture are different access switches supporting the various server functions.

Data Center Architecture

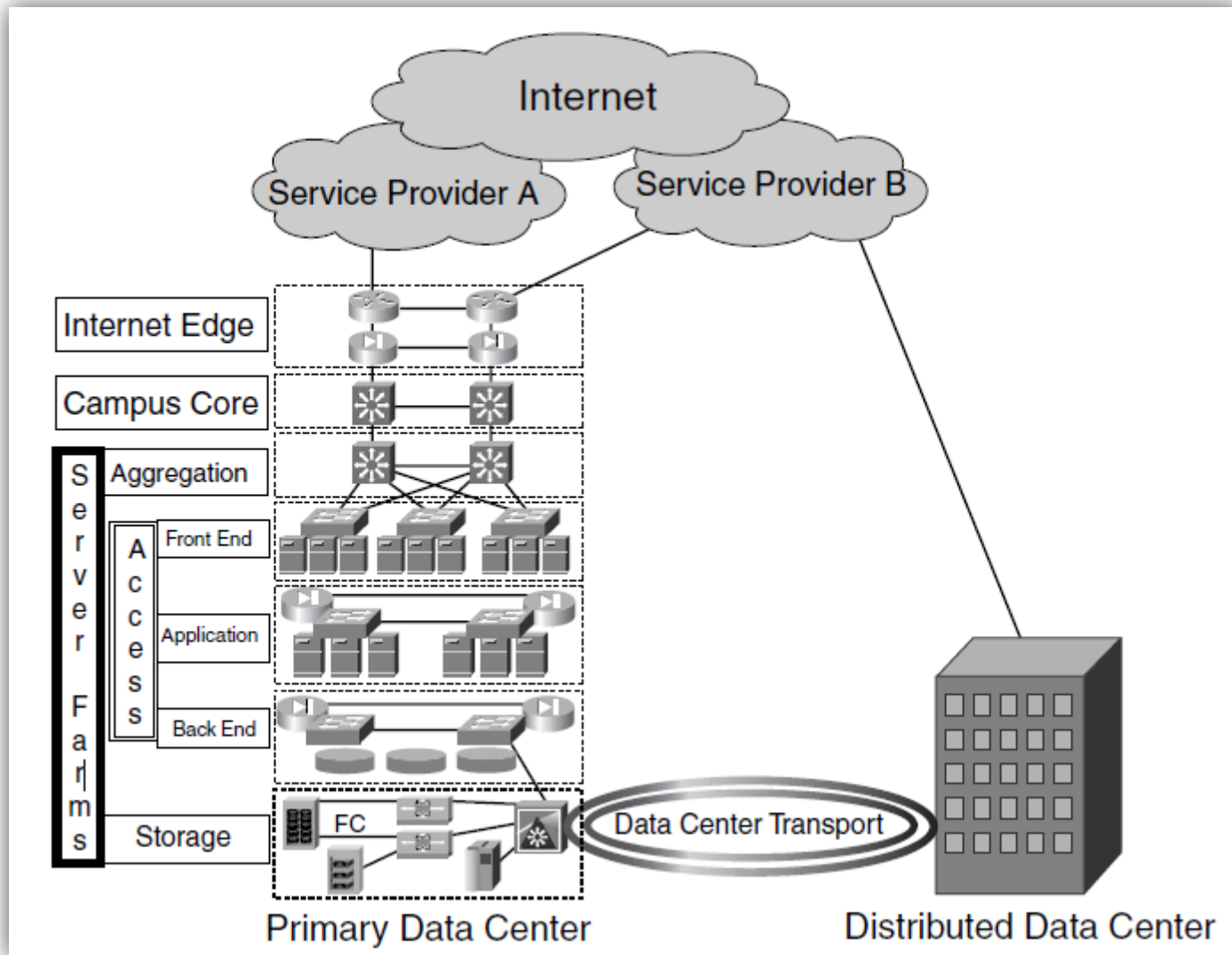

Fig. Topology of an Enterprise Data Center Architecture

Data Center Architecture

Figure 1-5 shows a fully redundant enterprise Data Center supporting the following areas:

- No single point of failure—redundant components
- Redundant Data Centers

Data Center Architecture

The Internet Edge provides the connectivity from the enterprise to the Internet and its associated redundancy and security functions, such as the following:

- Redundant connections to different service providers
- External and internal routing through exterior border gateway protocol (EBGP) and interior border gateway protocol (IBGP)
- Edge security to control access from the Internet
- Control for access to the Internet from the enterprise clients

Data Center Requirements

Data Center Prerequisite

Structure
Cabling performance
Redundancy
Grounding/potential equalization
Tier classification
Cable routing
Ceilings and double floors
Floor load
Space requirements (ceiling height, door width)
Power supply/UPS
Fire protection/safety
Cooling
Lighting
Administration/labeling
Temperature/humidity

Engineering Plan and Space Design

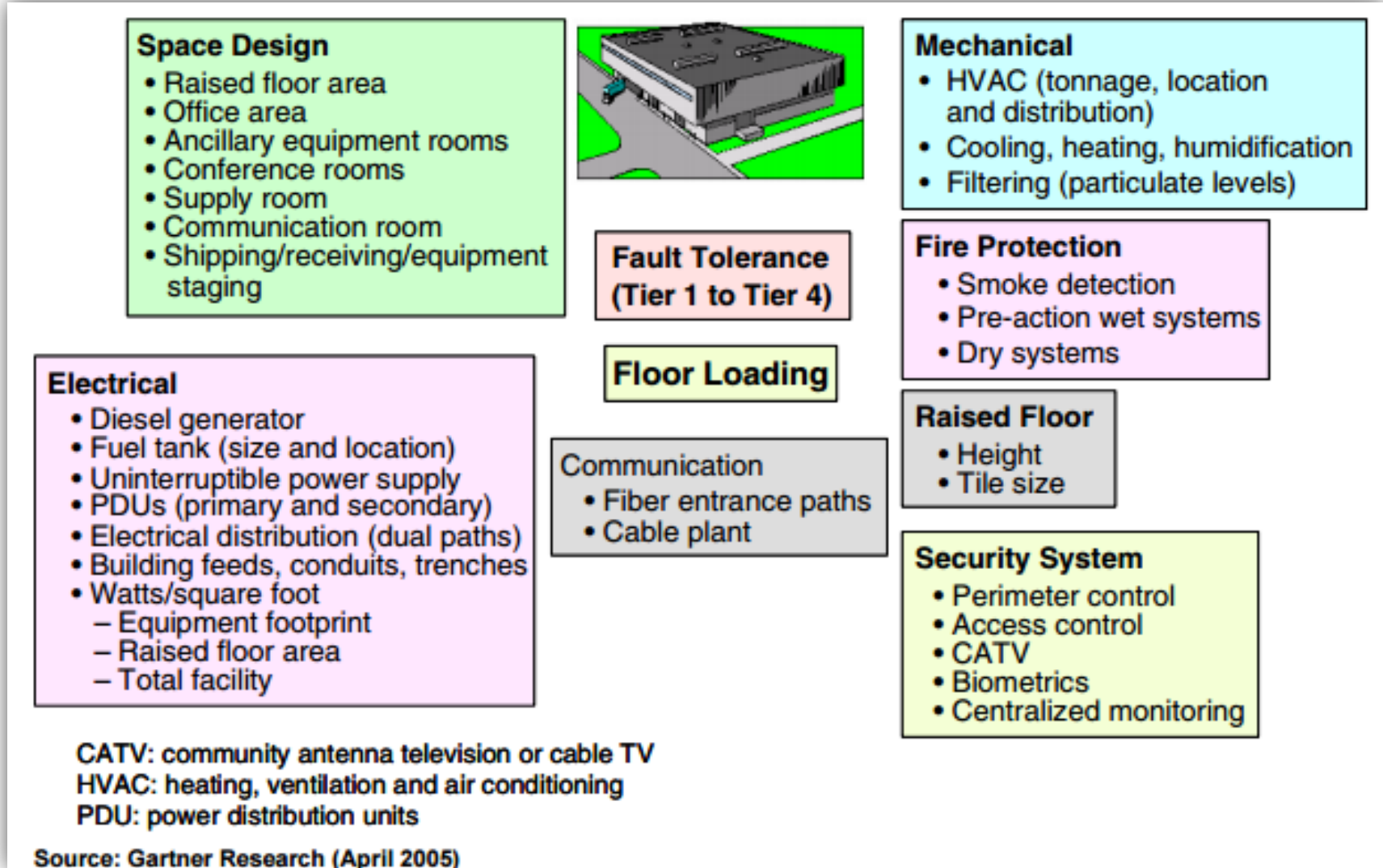

Fig. Data Center Prerequisites [Engineering Plan and Space Design]

Location Selection

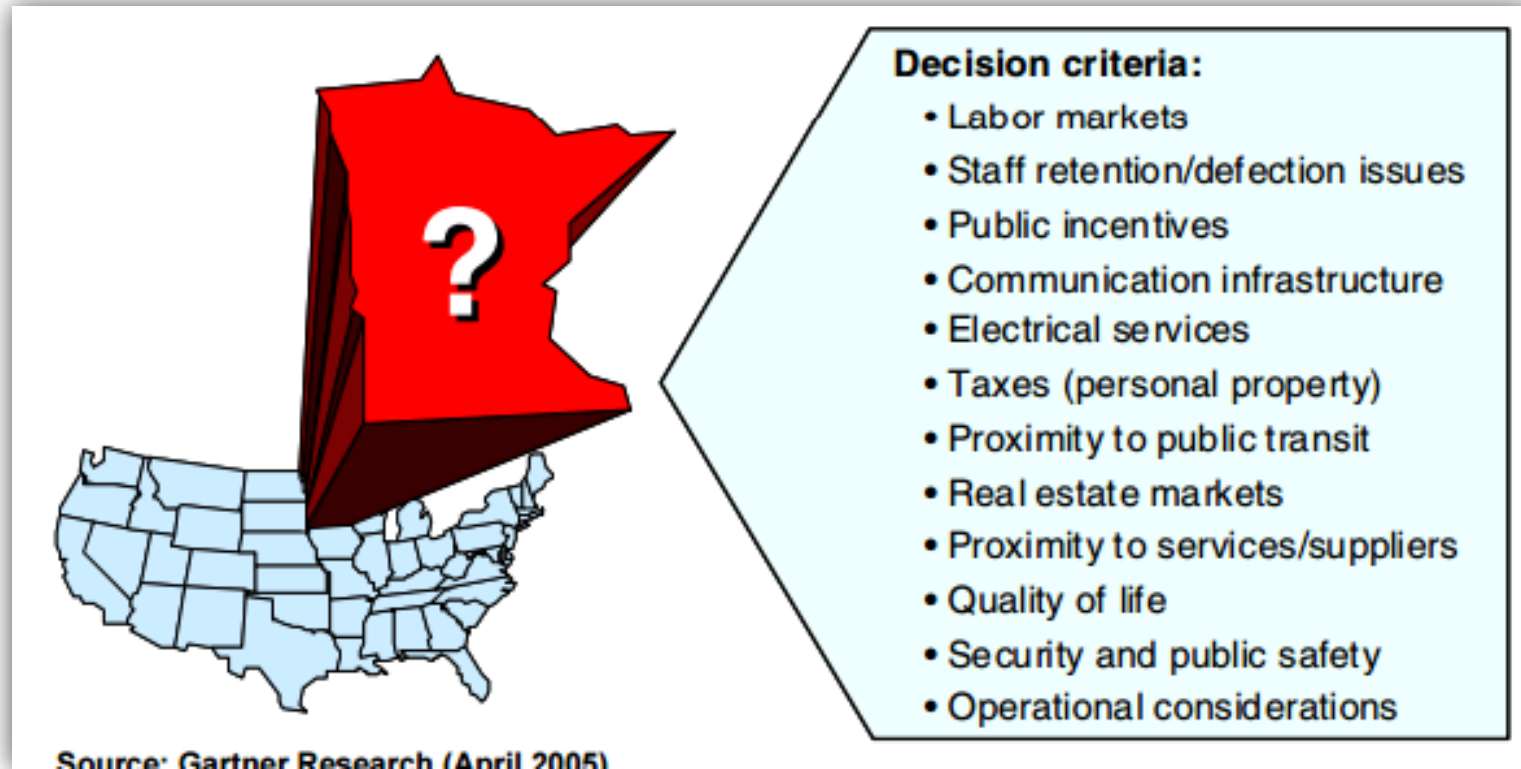
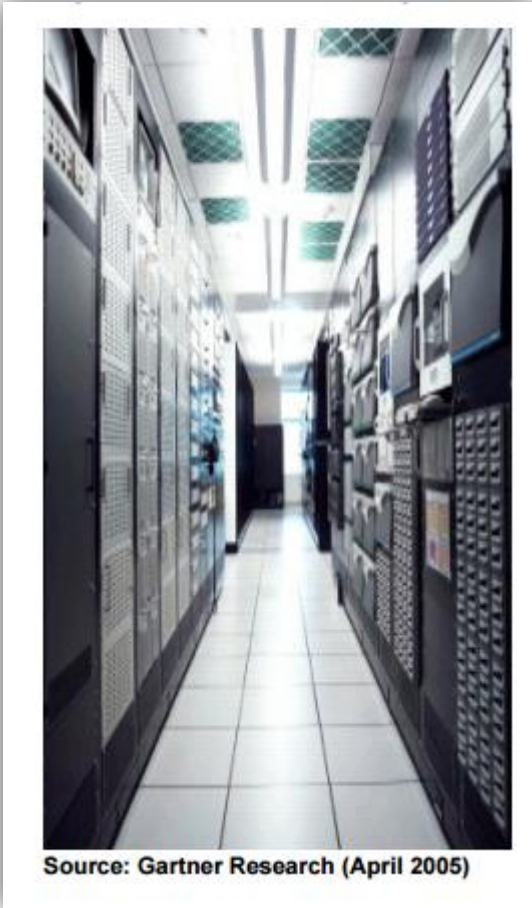

Fig. Location Selection

Required Physical Area for Equipment and Unoccupied Space



Source: Gartner Research (April 2005)

Figure 10. Site and Building Selection Criteria

Site/Location

- Preferably not near residential or other sound-sensitive users
- Maximum of one-hour distant commutation from major end users
- Adequate site for at-grade development (for example, parking, water storage, fuel storage, transformer yard or substation or generators)
- Ready access to power from diverse sources (such as multiple grids)

Site/Location

- Truck access for equipment delivery
- Assess proximity to sources of vibration and high-risk sources (such as airports and rail lines)
- Location outside flood plains and tornado- and hurricane-prone areas
- Local authorities amenable to building use

Site Location

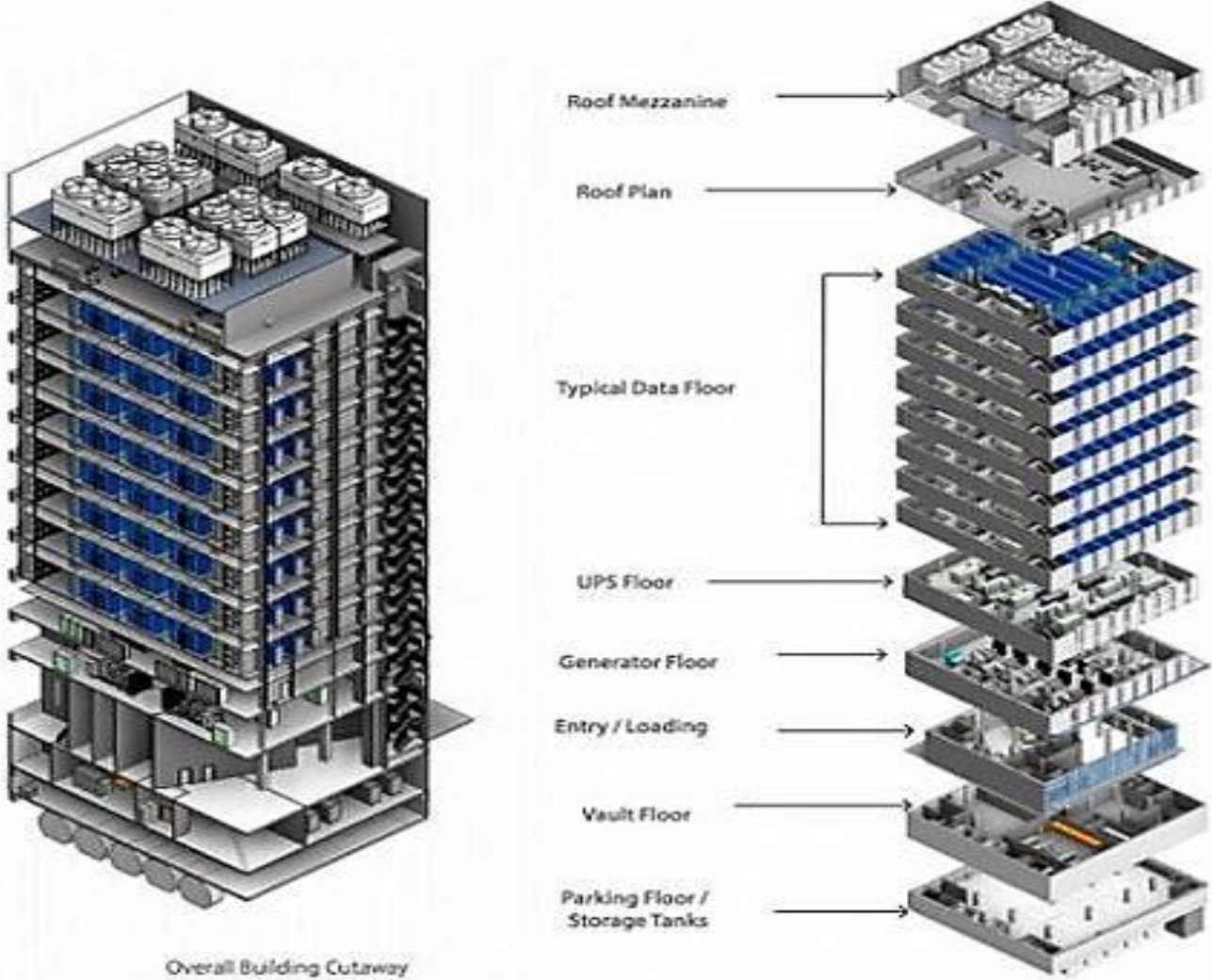

A cutaway of the proposed data center (source: public documents, Seattle.gov)

Site and Building Selection Criteria

- Larger column bays (30 feet x 50 feet is good) Minimum 13 ½ feet clear from structural slab to lowest structural member
- Efficient floor plates (that is, rectangular, square or side core preferable)
- 50,000 to 75,000 usable square feet preferable
- Minimal fenestration; hardened facilities preferred
- Good roof — level roof without skylights

Site and Building Selection Criteria

- Loading docks for equipment delivery access
- Compactor for rubbish removal
- Single point of entry and sufficient setback of building for perimeter security purposes
- Multiple story only: adequate riser space for primary/emergency power, HVAC, diverse fiber entries and other vertical services
- Rooftop acoustic and aesthetic screening for mechanical equipment

Site and Building Selection Criteria

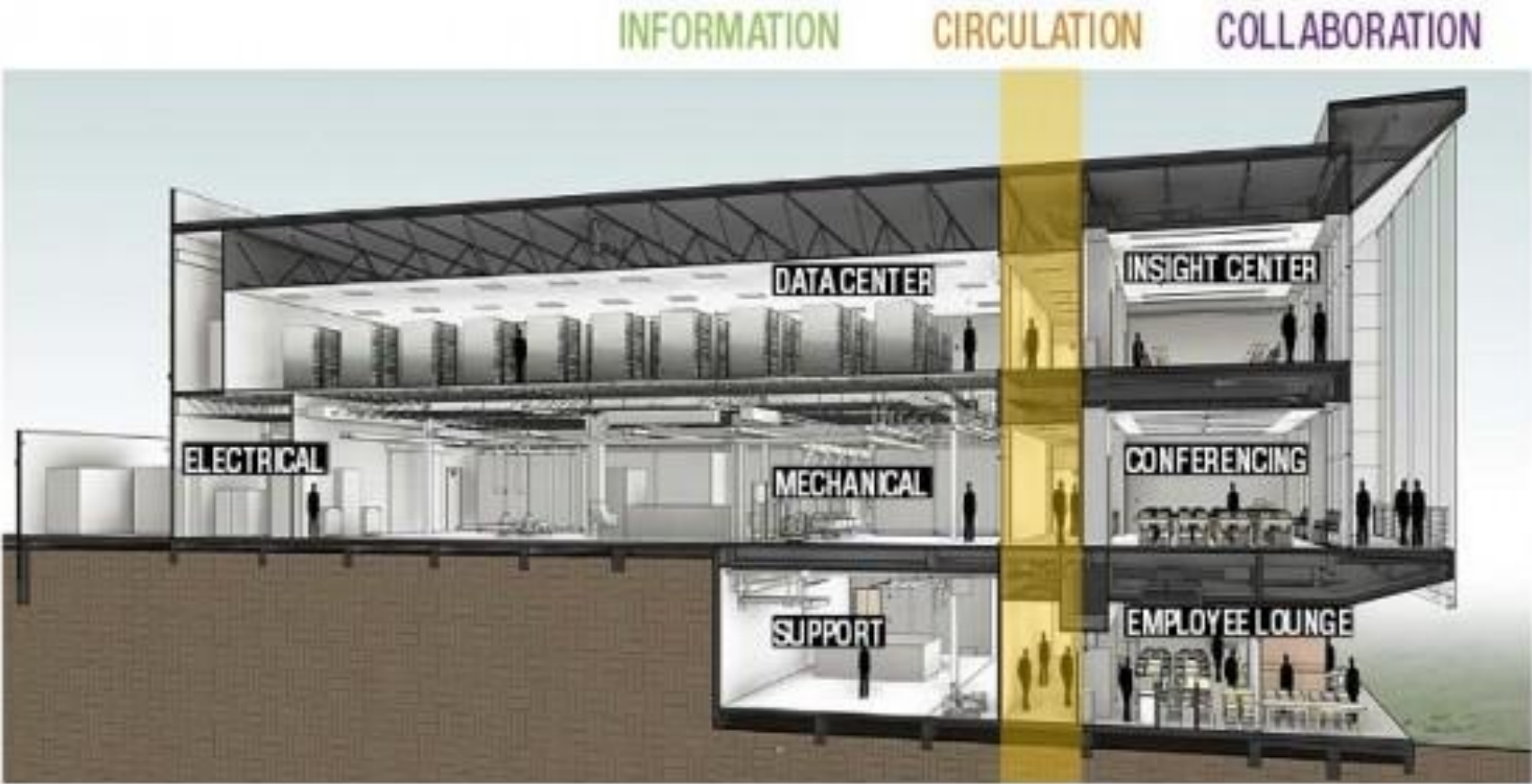

Cross section view into the ESIF HPC data center. Illustration from SmithGroupJJR

Selecting a Geographic Location

Safe from Natural Hazards

- Ideally a data center must be located in an area with no possibility of floods, fire, tornadoes, strong winds, or earthquakes.
- Since it is impossible to find such an area, you must identify the hazards that are most likely to occur within the data-center lifetime (10, 20, or even 30 years) and make provisions to mitigate their impact.
- Areas near a river, in a valley, or at the bottom of a hill are prone to floods.
- In an earthquake, the entire building should be built so that it will gently rock but will not get warped or cracked.
- One data center in Northern California had rollers below the outer walls of the building.

Selecting a Geographic Location

Safe from Man-Made Disasters

- Nature is not the only cause of an ill-suited site for a data center. Many human caused hazards are equally liable.
- A data center should not be located very close to an airport, electrical railways, or telecommunications signal center.
- They create a high level of radio frequency interference (RFI) and electromagnetic interference (EMI) that hamper computer network and hardware operations.
- Avoid selecting a site too close to a mine, quarry, highway, or heavy industrial plant whose vibrations may disrupt racks and servers within the data center or utilities outside the data center.

Power Distribution

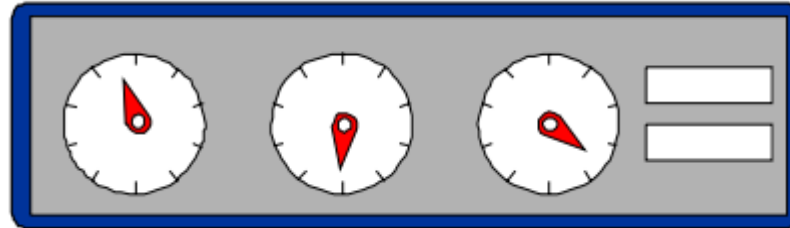

Fig. Power Distribution

- Assess overall power requirements (that is, use rack unit measure).
- Strive for multiple utility feeds.
- Provide for maintenance bypass and emergency shutdown.
- Determine if equipment requires single phase or three-phase power. –

[**Watch Video 1**](#)

[**Watch Video 2**](#)

[**Watch Video 3**](#)

Power Distribution

- For grounding and bonding, comply with Article 250 of the NEC unless superseded by local codes.
- Provide for a signal reference grid (SRG) to reduce high-frequency impedance.
- Use power distribution units (PDUs) to integrate circuit breakers and equipment connections.
- Maintain relative humidity levels to minimize electrostatic discharge.
- Be mindful of electromagnetic interference (EMI); conduct study to determine if shielding or other preventive measures are required.
- Use power-conditioning equipment or integrate into uninterruptable power supply (UPS) system. Use higher-gauge wire for future expansion.

[Watch Video](#)

UPS

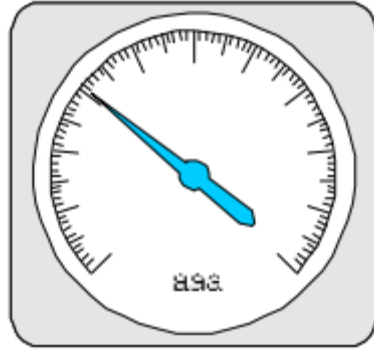

Uninterruptible Power Supply (UPS):

- Sized to power 100 percent of the equipment until backup power kicks in.
- Also sized for "peak" load or fault overload conditions.
- Should be continually online to filter and condition power.
- If UPS is not used, then surge protection should be provided at the panels with a stand-alone isolation/regulation transformer.

[Watch Video](#)

[Watch Video](#)

Grounding

- Every building in which electrical devices are operated requires an appropriate grounding concept.
- Grounding and the ground connection affect safety, functionality and electromagnetic interference resistance (EMC: electromagnetic compatibility).
- By definition, electromagnetic compatibility is the ability of an electrical installation to operate in a satisfactory manner in its electromagnetic environment, without improperly affecting this environment in which other installations operate.

Grounding

- The grounding system of buildings in which IT devices are operated must therefore satisfy the following requirements:
 - Safety from electrical hazards
 - Reliable signal reference within the entire installation
 - Satisfactory EMC behaviour, so all electronic devices work together without trouble

Grounding

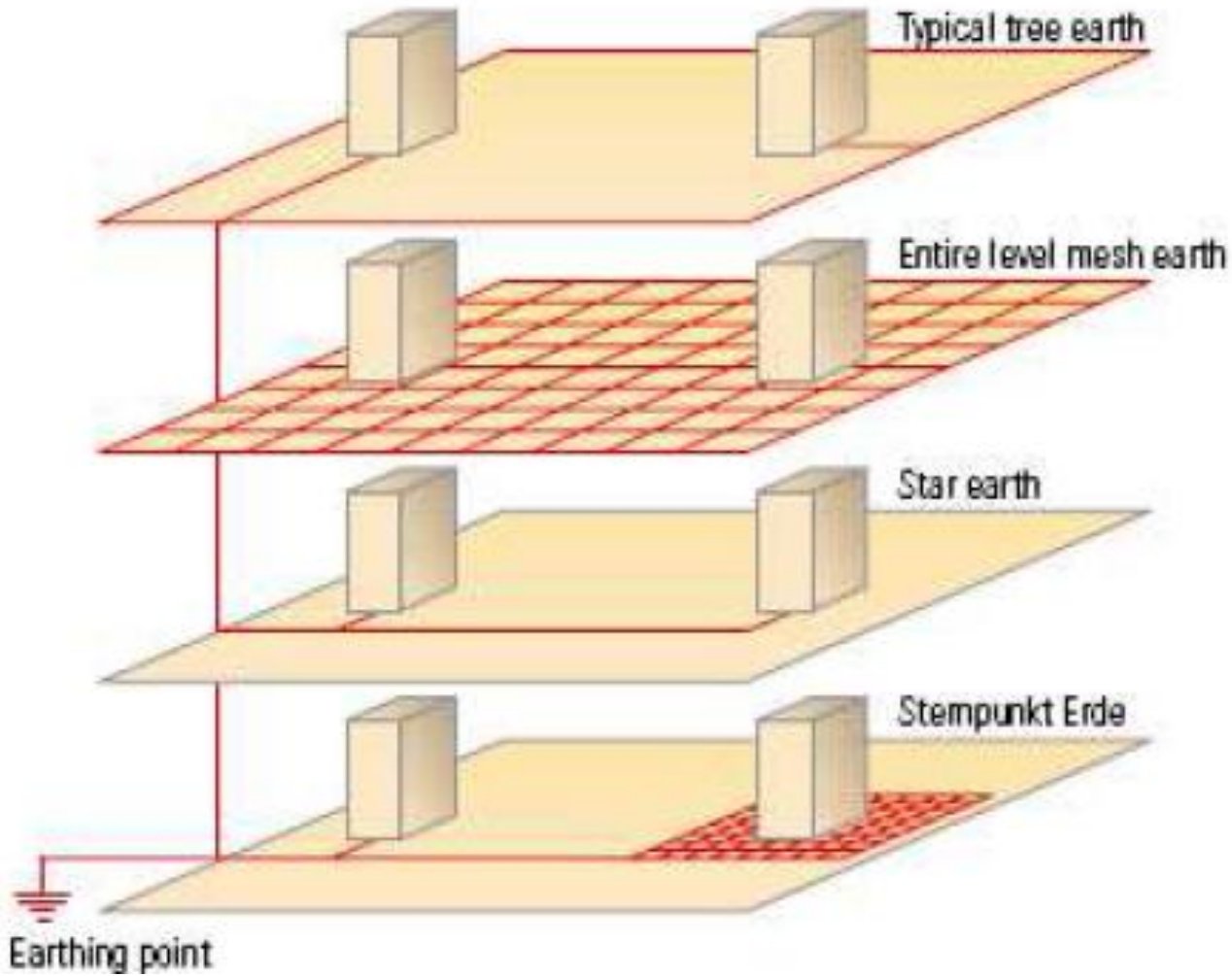
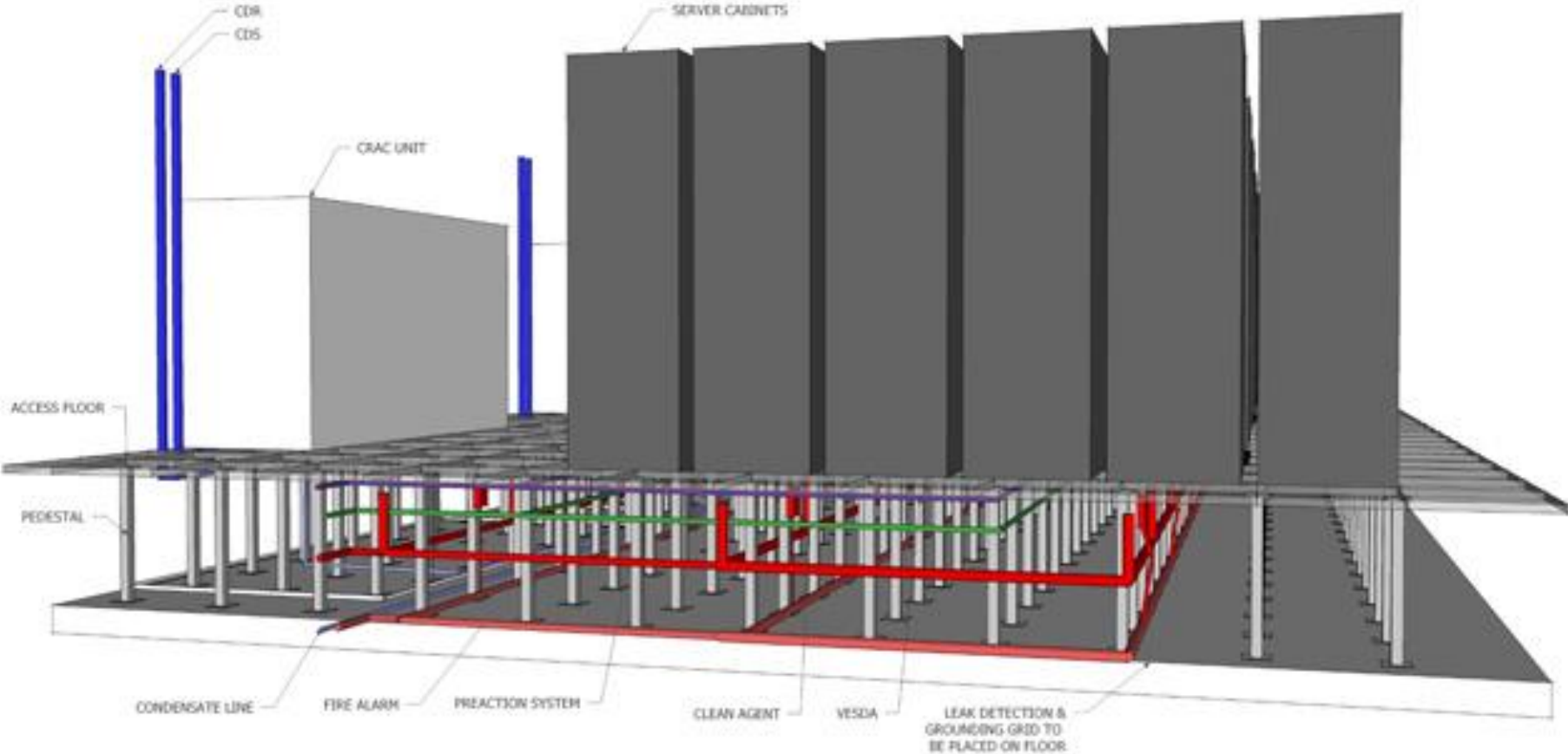

Fig. Grounding System

Grounding



Backup Generators

- Needed to achieve Tier 3 and Tier 4 fault tolerance.
- Required if outages in excess of 20 minutes are anticipated.
- Consider local code compliance regarding fuel storage and noise abatement.
- Consider exhaust and vibration effects.
- Plan for maintenance and diesel fuel contracts.
- Plan for periodic test of the generators.

Mechanical Systems (HVAC)

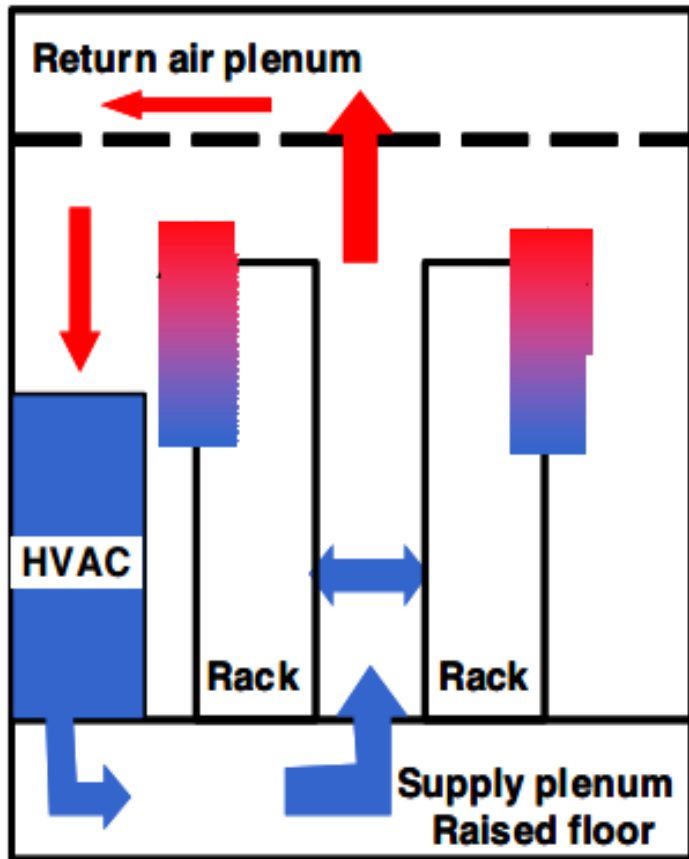

Strive for redundancy in the HVAC system by installing multiple units; focus on rack and tile placement to maximize the efficient flow of chilled air; use spot cooling as needed.

Key Considerations:

- Temperature — 70 to 74 degrees F
- Relative humidity — 45 % to 50 %
- Bottom-to-top airflow

Mechanical Systems (HVAC)

- Avoid centralized systems — opt for distributed units
- Use cold aisle/hot aisle rack configuration
- Maintain static pressure at 5 % above room pressure
- Avoid air leaks in raised floor
- Use spot cooling as needed
- Maintain vapour barrier in perimeter, doorways and subfloor area

HVAC-Plenum

Plenum

- The word *plenum* (pronounced PLEH-num) means “full” in Latin.
- It is the space between the data center subfloor and the floor tiles and is usually between 1 1/2 to 2 feet in height. The HVAC must be capable of pressurizing the plenum.
- The open structure in the plenum contains a floor grid system (pedestals and stringers) that must be strong enough to support the tiles and maximum expected weight on the tiles (such as equipment-filled racks), HVAC units, dollies, forklifts, and people in the data center.
- The plenum contains the power outlets and network cables for equipment in the racks.

Raised Floors

Specify a raised-access floor (RAF) height relative to the overall data center size; consider using cast aluminium floor tiles to ensure maximum floor loading capability.

Raised-Floor Height Levels

Facilities with less than 1,000 sq. ft.	12-inch RAF height
Facilities with 1,000 to 5,000 sq. ft.	12- to 18-inch RAF height
Facilities with 5,000 to 10,000 sq. ft.	18- to 24-inch RAF height
Facilities with 10,000 sq. ft.	24-inch RAF height

Advantages:

- Provides for superior chilled airflow distribution pattern (bottom to top)
- Ease of electrical and signal circuit changes
- Easier to maintain separation of power circuits from signal cabling
- Life cycle costs compare favorably with vinyl chloride tile flooring:
 - Raised floor — \$19.95 to 21.70 per sq. ft.
 - VCT — \$20.00 to 22.00 per sq. ft.

RAF: raised-access floor

Source: Gartner Research (April 2005)

Raised Floors and Dropped Ceilings

- The raised floor, ideally 80 centimeters in height, also has a great influence in the area of hot and cold aisles.
- Among its other functions, the floor is used to house cabling. Since the floor is also the air duct, cables must not run across the direction of the current and thus block the path of air flow.
- One must therefore think about running the cabling in the ceiling and only using the raised floor for cooling, or at least reducing it to the area of the hot aisle.

Raised Floors and Dropped Ceilings- Structure

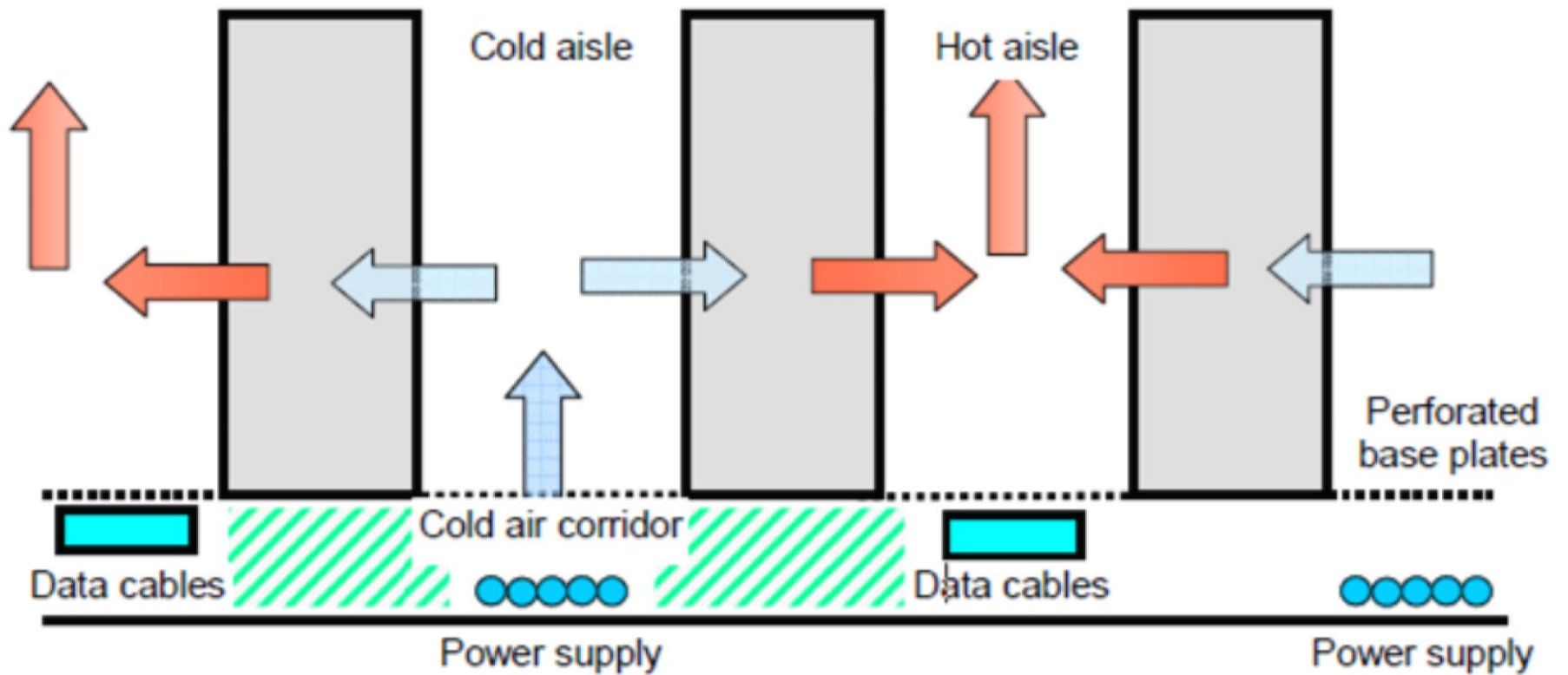

Raised Floors and Dropped Ceilings

- Depending upon building conditions, possible solutions for data center cable routing include the raised floor, cable trays suspended from the ceiling or a combination of these two solutions.
- The supply of cold air to server cabinets may not be restricted when cables are routed through the raised floor.
- It is recommended that copper and fiber optic cables be laid in separate cable trays. Data and power supply cables must be separated in accordance with EN 50174-2 standards.
- The cable trays at the bottom need to remain accessible when multiple cable routes are arranged on top of one another.

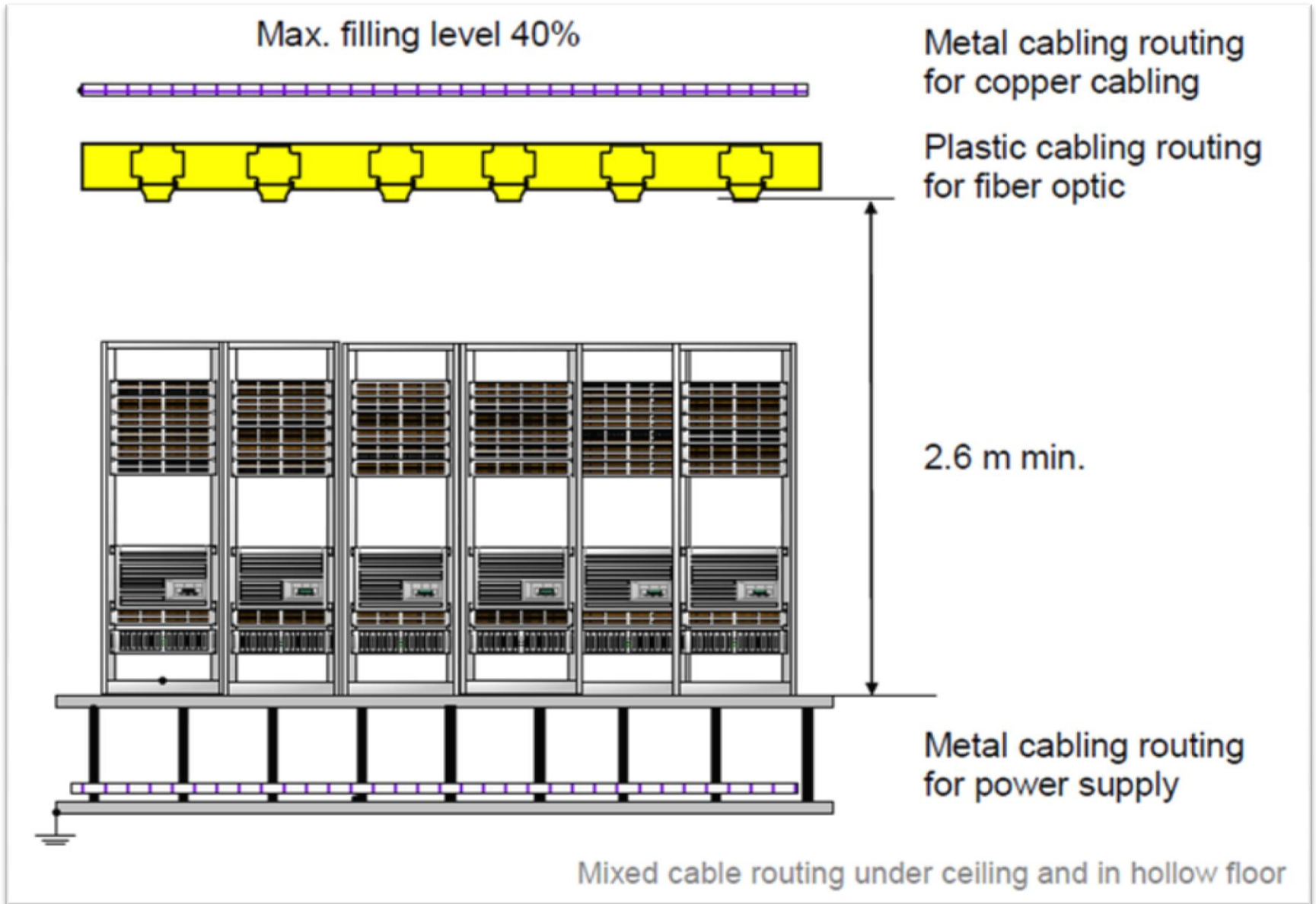

Raised Floors

- The alternative to raised floors would be using vinyl chloride anti-static tiles, which presume lower installation costs.
- Gartner research confirms that RAFs provide the most-efficient and cost effective solution for managing electrical and signal cable management, as well as providing the most-efficient distribution of chilled air throughout the data center.
- The raised floor also provides a superior signal reference ground (SRG), whereby the reference grid is mechanically bonded to the access floor system.
- In terms of raised floor heights, Gartner recommends a 12-inch raised floor for smaller data centers (that is, 1,000 square feet or less).

Raised Floors

- For larger centers of between 1,000 and 5,000 square feet, an 18-inch height is recommended.
- For centers greater than 5,000 square feet, a 24-inch height will be required.
- The raised floor provides an optimum plenum for chilled air for modern computer equipment that is typically designed for bottom-to-top airflow.
- In addition, the raised floor provides a more suitable environment for electrical and signal cable management. In terms of life cycle costs, the raised floor compares favourably with vinyl tile installation. [5]

Fire Detection and Suppression

Detection:

- Both heat and smoke detection
- Installed in accordance with NFPA 72E
- Installed below raised floors and other areas
- Location specifically designed in relation to airflow patterns

Suppression:

- Follow NFPA 75 standard firewalls
- Sprinkler systems — both flooded and pre-action
- Chemical systems:
 - FM 200
 - Inergen
 - Ecaro-25(FE 25); Novec 1230
 - Halon 1301 (no longer recommended or in production)
- Manual systems
 - Manual pull stations
 - Portable fire extinguishers

Source: Gartner Research (April 2005)



Data Center Construction Costs

Cost Line Item
1. Demolition
2. General construction
3. Access floor system
4. Ceiling systems
5. Wall finishes
6. Floor finishes
7. Structural steel
8. Fire protection system
9. Plumbing systems
10. Mechanical systems
11. Electrical systems
12. Monitoring and security systems
13. Critical support equipment
14. General conditions
15. General contractor fee
16. Permit
17. Premium time
18. Construction management fee
19. Design fee
20. Reimbursable expenses

Complete a value engineering study of data center construction costs and associated life cycle costs. Focus particularly on diesel power, UPS and electrical system design.

Cost Line Item	Total Average Cost	Average Cost Per Sq. Ft.	% of Total
1. Demolition	\$18,965	\$1.79	
2. General construction	276,293	26.11	6.6%
3. Access floor system	124,773	11.79	
4. Ceiling systems	31,978	3.02	
5. Wall finishes	30,591	2.89	
6. Floor finishes	24,844	2.35	
7. Structural steel	123,868	11.70	
8. Fire protection system	141,736	35.77	
9. Plumbing systems	35,883	3.39	
10. Mechanical systems	503,066	47.54	12.0%
11. Electrical systems	909,728	85.96	21.6%
12. Monitoring and security systems	34,475	3.26	
13. Critical support equipment	863,429	81.59	20.5%
14. General conditions	195,187	18.44	
15. General contractor fee	113,569	10.73	
16. Permit	17,549	1.66	
17. Premium time	91,935	8.69	
18. Construction management fee	156,793	14.82	
19. Design fee	156,793	14.82	
20. Reimbursable expenses	17,396	1.64	
Total project	\$4,202,665	\$397.11	100%

Average data center cost:

Tier 2

10,583 SF (raised floor)
13,029 SF (total facility)
11 facilities

Uninterruptible power supply: diesel generator

Source: Technology Management Inc.

Cabling Systems

The communications cabling system is essential to the availability of IT applications in data centers.

Without a high-performance cabling system, servers, switches, routers, storage devices and other equipment cannot communicate with each other and exchange, process and store data.

However, cabling systems have often grown historically and they are not fully capable of meeting today's requirements.

This is because today's requirements for data centers are high:

- High channel densities
- High transmission speeds
- Interruption-free hardware changes
- Ventilation aspects
- Support

[Watch Video](#)

[Watch Video](#)

Cable Runs and Routing

- The cable routing system in the data center must fulfil the following demands.
 - It must satisfy cabling requirements so no losses in performance occur
 - It must not obstruct the cooling of active components
 - It must fulfil requirements of electromagnetic compatibility (EMC)
 - It must support maintenance, changes and upgrades

Cable- Tray

Tray

- The advantage of a cable tray is that cables are better protected mechanically.
- According to the results of a test carried out by the laboratories of Labor, A EMC Mesure and CETIM, a tray does not essentially provide better electromagnetic protection than a mesh cable tray.
- A key disadvantage of trays that must be mentioned is that only trays should be used which prevent cable damage at the cable entry and exit points using appropriate edge protection.
- In the case where an exit point is added later, it is very difficult to implement the edge protection and thus the cable could be damaged.
- Providing an additional cover reduces the danger that “external cables”, such as power cables for post construction cabling, may be laid on data cables and impair their operation.

Tray

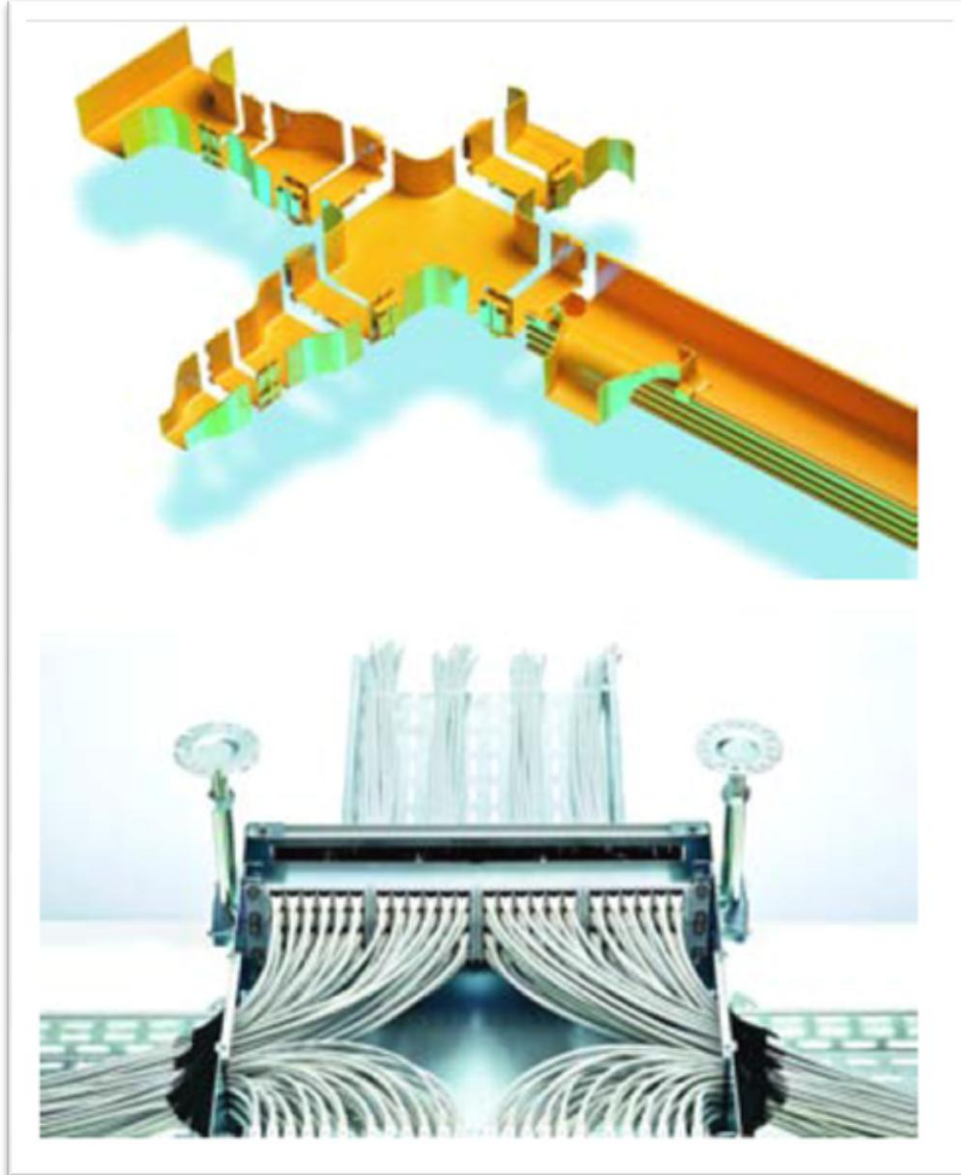

Cable-Tray

Mesh Cable Tray

- A mesh cable tray does not provide the same mechanical protection as the regular cable tray described above.
- The cable support points on grid bars may mechanically damage cables at the bottom of the tray, in the case of higher cable densities.
- This risk can be definitively reduced if a metal plate, which prevents cable point pressure, is placed on the base of the mesh cable tray.
- The advantage of the “open” mesh cable tray lies in its improved ability for cables to be routed out.
- The option of using an additional cover is an exceptional case when using mesh cable trays, but is a possibility with certain manufacturers.

Cable-System Selection

Due to the requirement of maximum high availability and ever increasing data transmission rates, quality demands on cabling components for data centers are considerably higher than on those for LAN products.

Quality assurance thus starts in the early stages of planning, when selecting systems that meet the performance requirements listed here.

- Cable design of copper and fiber optic systems
- Bandwidth capacity of copper and fiber optic systems
- Insertion and return loss budget of fiber optic systems
- EMC immunity of copper systems
- Migration capacity to next higher speed classes
- 19" cabinet design and cable management

Cable

Structure

Data centers are subject to constant change, as a result of the short life cycles of active components.

To avoid having to perform major changes in the cabling system with the introduction of every new device, a well-structured, transparent physical cabling infrastructure that is separated from the architecture and that connects the various premises running the devices in a consistent, end-to-end structure is recommended.

Redundancy and Reliability

The requirement of high availability necessitates the redundancy of connections and components. It must be possible to replace hardware without interrupting operation, and in case a link fails, an alternative path must take over and run the application without any glitches. Proper planning of a comprehensive cabling platform is therefore essential, taking into account factors like bending radii, performance reliability and easy and reliable assembly during operation.

Cable

Installation

- In order to be qualified for installation and patching work in data centers, technicians need to be trained in the specifications of the cabling system.
- Another advantage of the above-mentioned factory-assembled cabling systems is the time saved during installation.
- Moreover, when extending capacity by adding IT equipment, the devices can be cabled together quickly using preassembled cabling, thus ensuring that the equipment and the associated IT applications are in operation in the shortest time; the same applies to hardware.
- Cable management is another important aspect. With growing transmission speeds, it is absolutely essential to run power and data cables separately in copper cabling systems so as to avoid interference.



Cable-Documentation and Labelling

- Related to documentation is the labelling of the cables; it should be unambiguous, easy to read and readable even in poor visibility conditions. Here too, numerous options exist, up to barcode-based identification labels.
- Which option is best depends on specific data center requirements.
- Maintaining uniform, company-wide nomenclature is also important. To ensure unambiguous cable labelling, central data administration is recommended.

COOLING

Cooling, Hot and Cold Aisles

- Every kilowatt (kW) of electrical power that is used by IT devices is later released as heat.
- This heat must be drawn away from the device, cabinet and room so that operating temperatures are kept constant.
- Air conditioning systems, that operate in a variety of ways and have different levels of performance, are used to draw away heat.
- Providing air conditioning to IT systems is crucial for their availability and security.
- The increasing integration and packing densities of processors and computer/server systems causes a level of waste heat that was unimaginable in such a limited space only a few years ago.

Cooling, Hot and Cold Aisles

- The decision criteria for an air conditioning solution include, among other things,
 - maximum expected dissipation loss,
 - operating costs,
 - acquisition costs,
 - installation conditions,
 - expansion costs,
 - guaranteed future and costs for downtimes and for physical safety.
- There are basically two common air conditioning types:
 - **Closed-circuit air conditioning**
 - **Direct cooling**

Aisles & Ramp

Aisles

- *Aisles* refer to the space between two rows of racks. Aisles and open space around corners and walls must be wide enough for moving racks and large, heavy equipment (movement that involves a forklift and few people).
- There must be enough space to remove and roll out a broken rack and roll in a new rack.
- Also, a large number of racks should not be placed in a continuous manner.
- There must be gaps after a set of continuous racks. Long rows of continuous racks make maneuvering from aisle to aisle, as well as from front to back of a rack, a time-consuming process.
- An optimally populated data center will have slightly more than half its area used by racks and stand-alone equipment.

Ramp

- Constructing a *ramp* is the most common and practical way to get equipment in or out of a data center.
- The ramp must support the weight of the equipment, people, and mechanical devices used to lift the equipment (such as electrical powered pallet jacks).
- Ramps that must support heavy weight are made of poured concrete.

Cooling, Hot and Cold Aisles

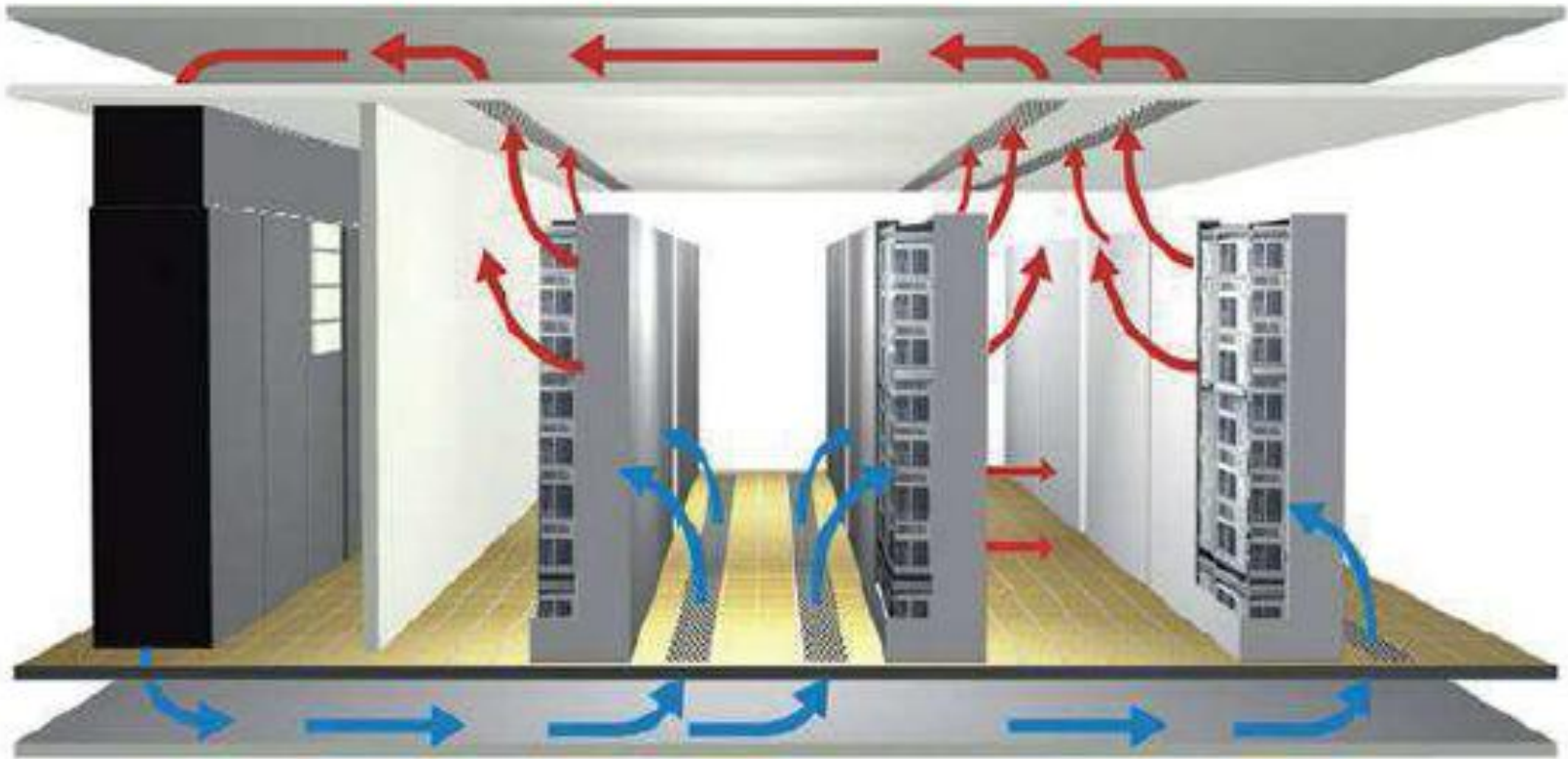
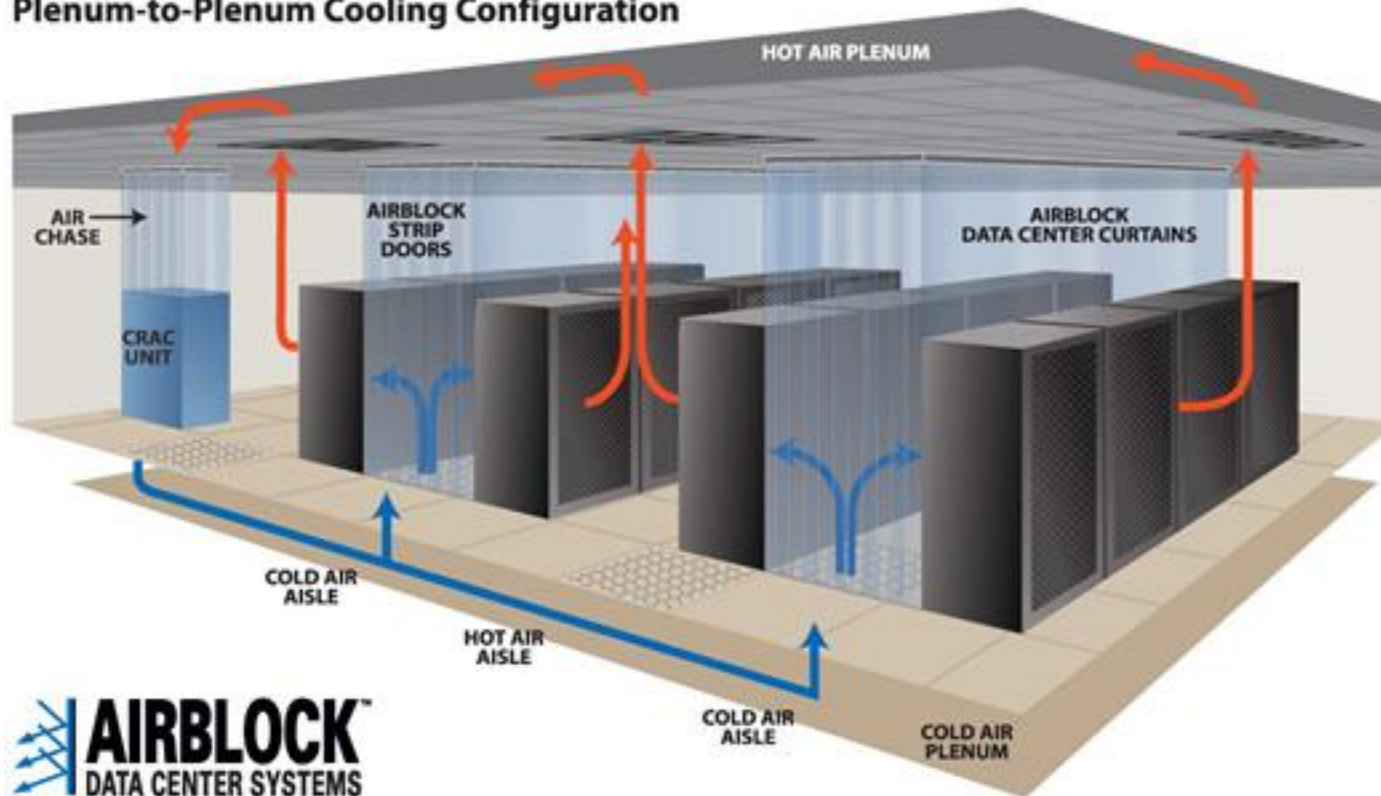

Fig. Solution per the cold aisle/hot aisle principle – closed-circuit air conditioning (Source: BITKOM)

Cooling, Hot and Cold Aisles

Plenum-to-Plenum Cooling Configuration



Cooling, Hot and Cold Aisles

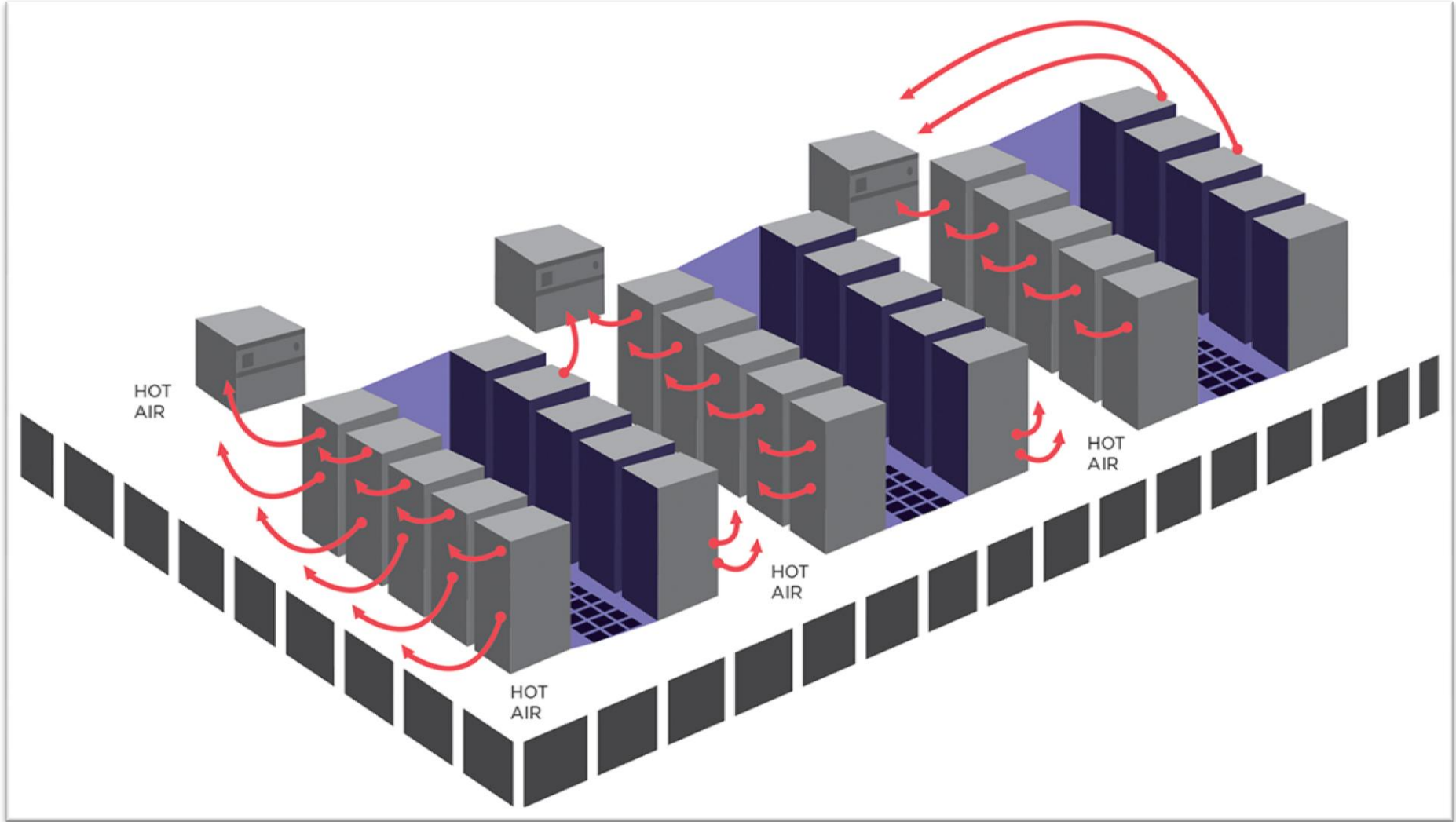

Fig. Cooling, Hot and Cold Aisles

Cold Aisle Containment

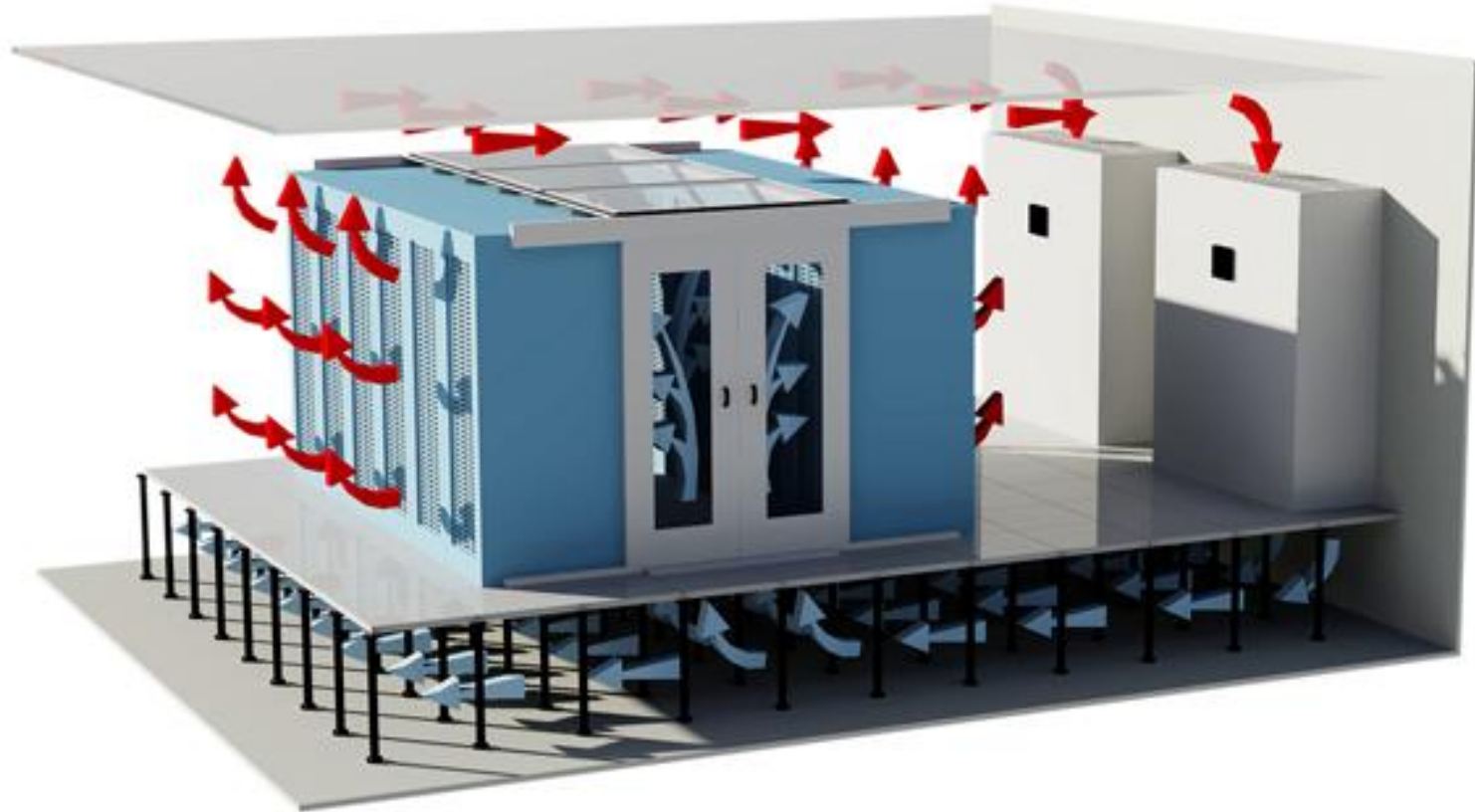

Fig. Cold Aisle Containment

Hot Air Return

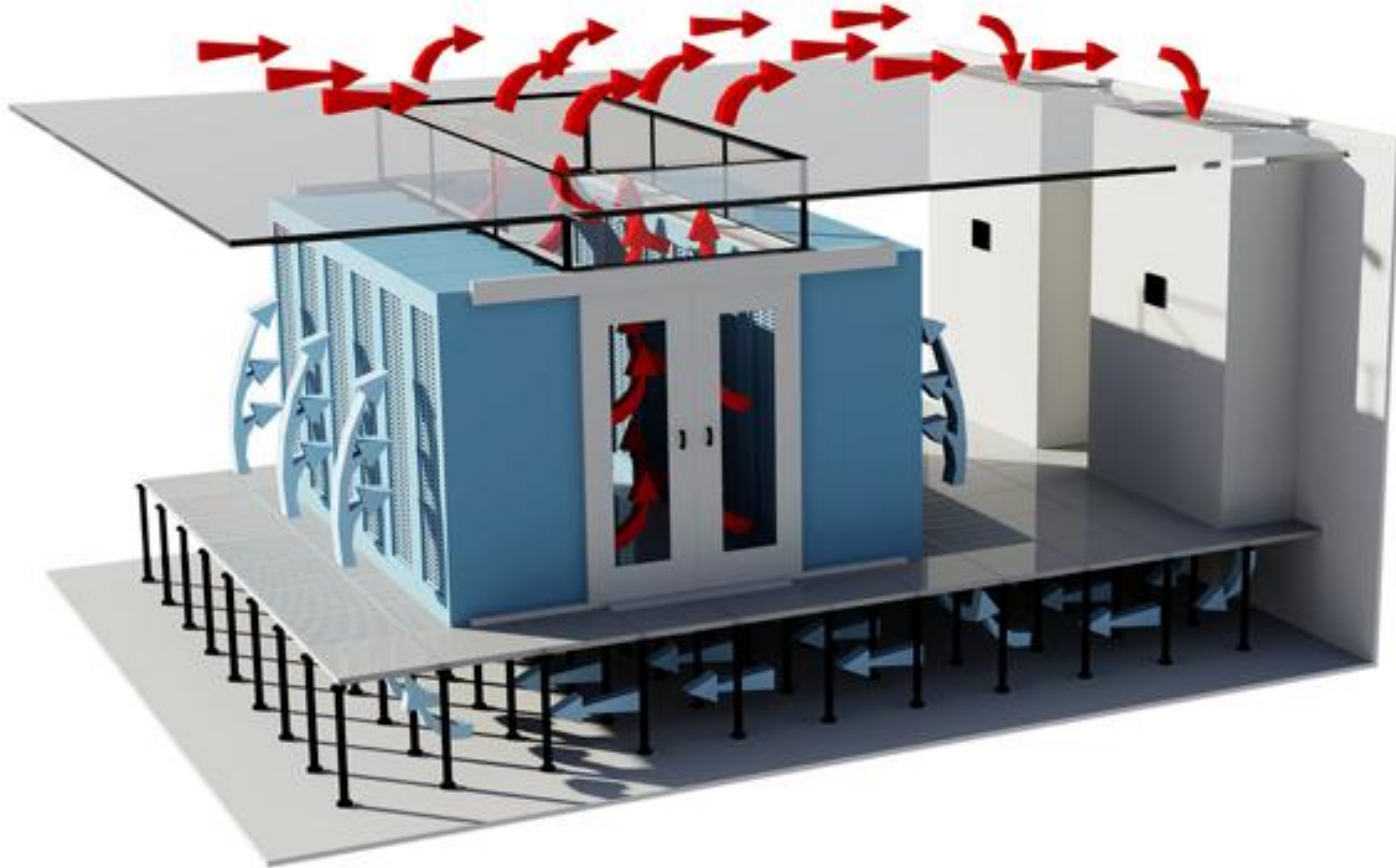

Fig. Hot Air Return

Closed-Circuit Air Conditioning Operation

- In the closed-circuit air conditioning principle,
 - the air cooled by the air conditioning system circulates to IT components,
 - takes in heat and the warmed air then reaches the air conditioning system again in the form of return air that is to be re-cooled.
- Only a small amount of outside air is introduced into the room that is to be air conditioned and used for air exchange.
- Optimal conditions with respect to temperature and relative humidity can only be achieved with closed-circuit air-conditioning units, or so-called precision air-conditioning units.

Closed-Circuit Air Conditioning Operation

- The energy used in these systems is better utilized, i.e. reducing the temperature of return air is the first priority.
- These units are contrasted with comfort air-conditioning units used for residential and office spaces, such as split air-conditioning units, which continuously use a large portion of the energy they consume to dehumidify recirculated air.
- This can lead not only to critical room conditions but also to significantly higher operating costs, which is why their use is not economically feasible in data centers.

Closed-Circuit Air Conditioning Operation

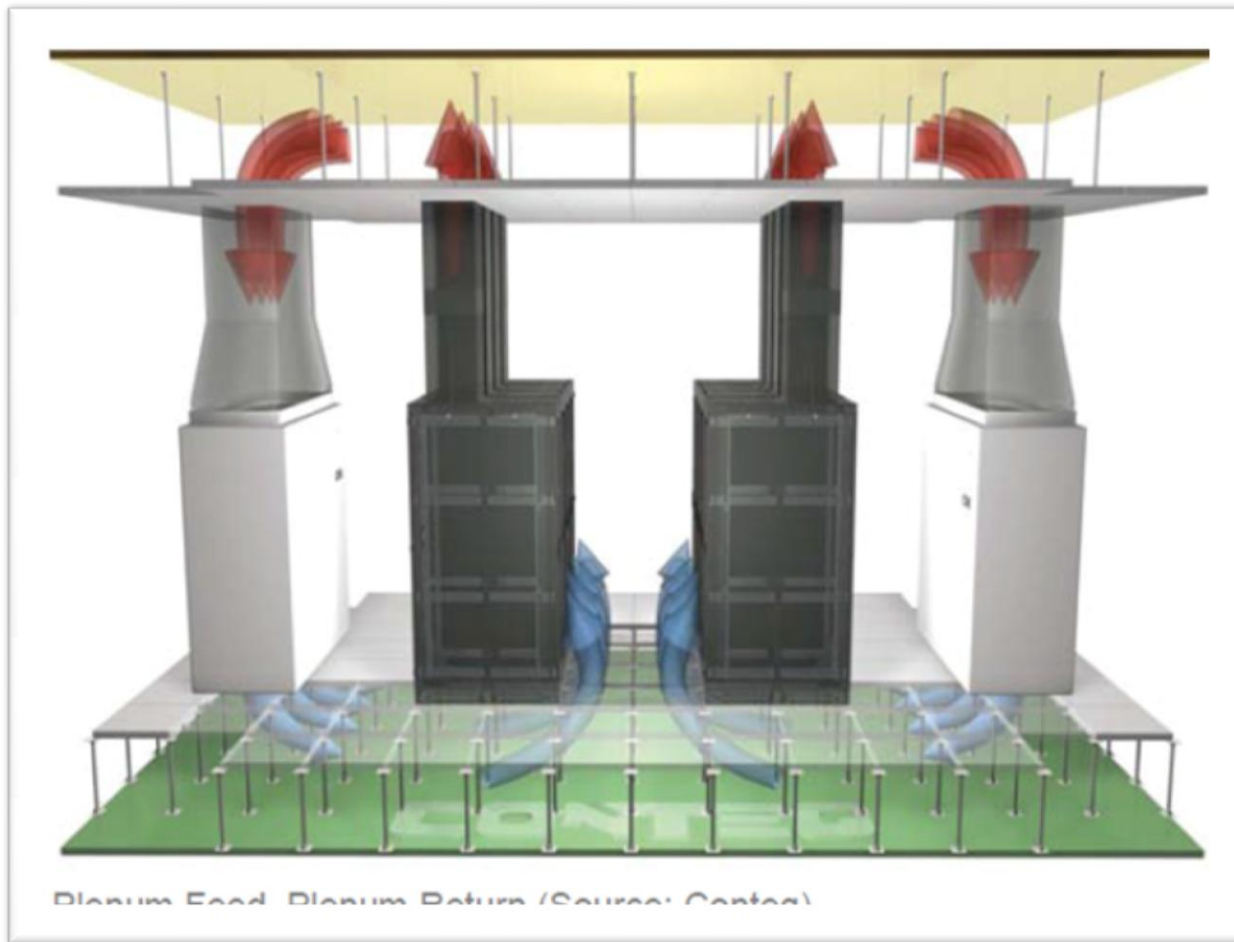
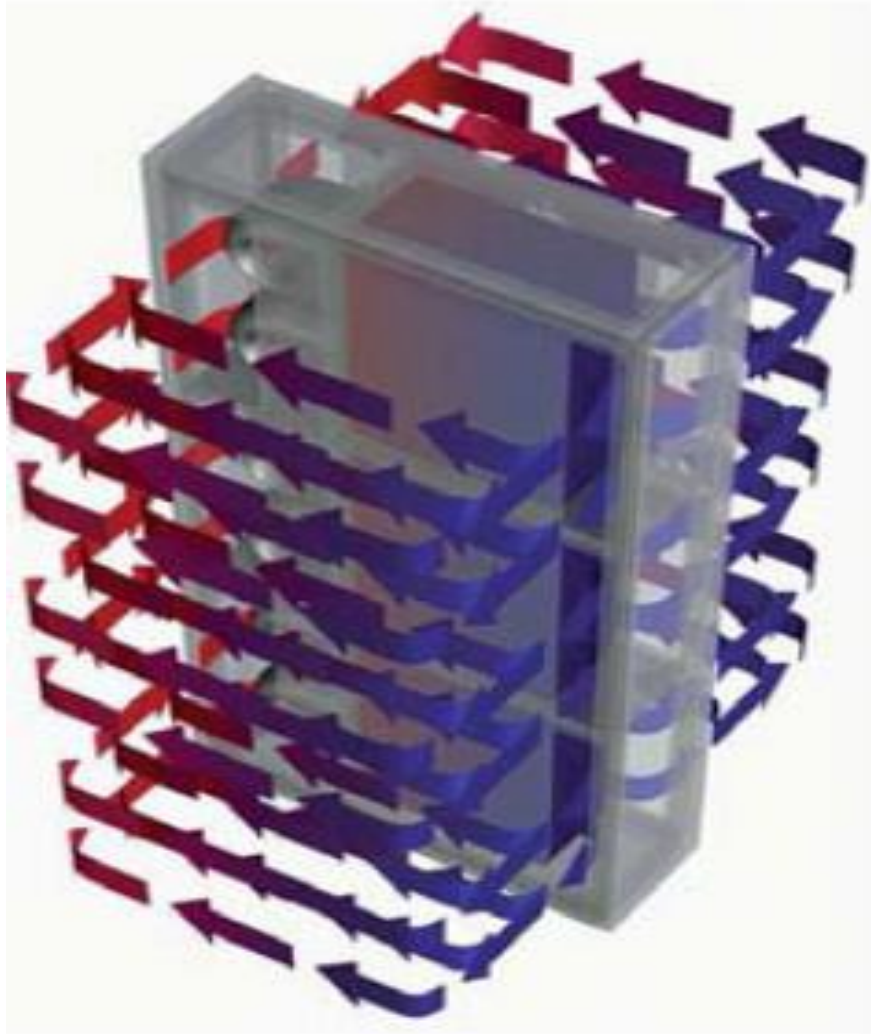

Fig. Closed-Circuit Air Conditioning Operation

Direct-Cooling Principle – Water-Cooled Server Rack



- Direct cooling of racks must be implemented when heat loads exceed 10 to 15 kW per cabinet.
- This is realized via a heat exchanger installed in the immediate vicinity of the servers. These are usually heat exchangers cooled with cold water, that are arranged either below or next to the 19" fixtures.

Fig. Direct-Cooling Principle –Water-Cooled Server Rack

Direct-Cooling Principle – Water-Cooled Server Rack

- Up to 40 kW of heat per rack can be drawn off in this way. A cold-water infrastructure must be provided in the rack area for this method.
- The water-cooled racks ensure the proper climatic conditions for their server cabinets, and are therefore self-sufficient with respect to the room air-conditioning system.
- In buildings with a low distance between floors, water-cooled server racks are a good option for drawing off high heat loads safely without having to use a raised floor.
- The high-performance cooling system required for higher power also includes a cold and hot aisle containment.

Cooling Overview

Air conditioning via raised floor without arranging racks for ventilation

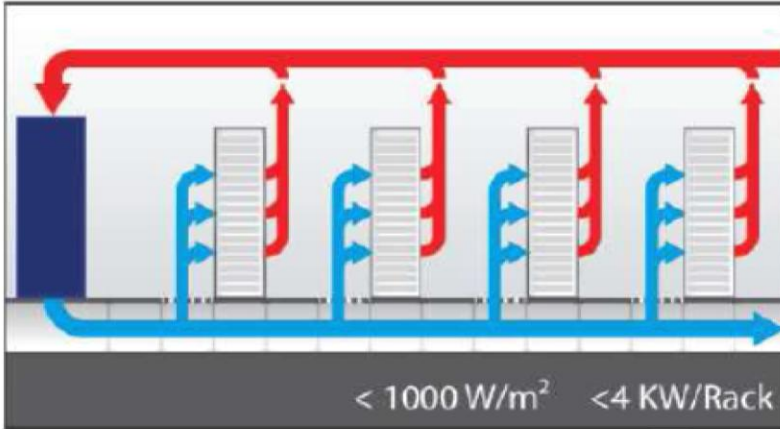

Air conditioning system with water-cooled housing for hot aisles

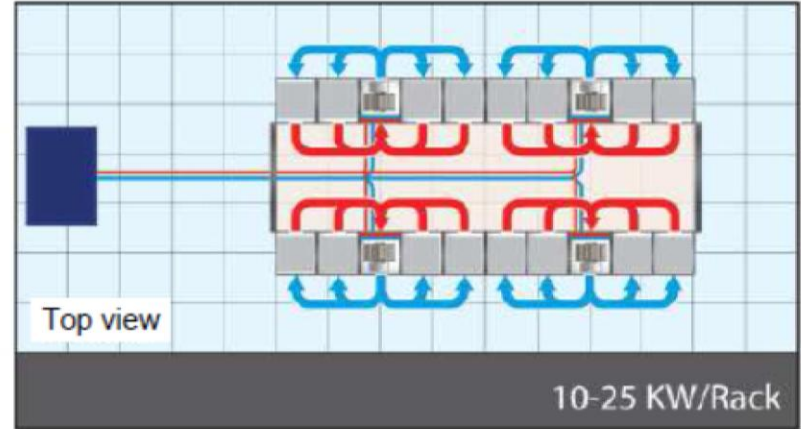

Air conditioning via raised floor with racks arranged in cold/hot aisles

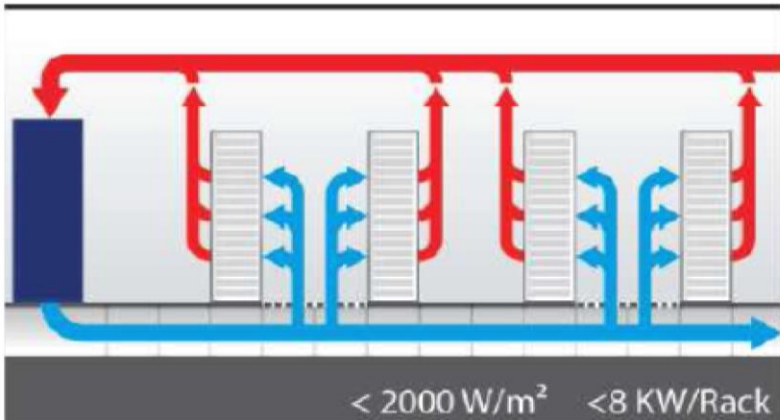

Air conditioning system with water-cooled housing for cold aisles

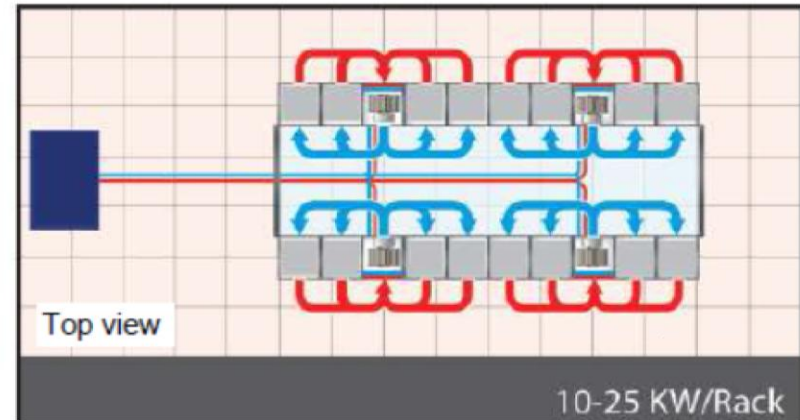

Cooling Overview

Air conditioning via raised floor with housing for cold aisles

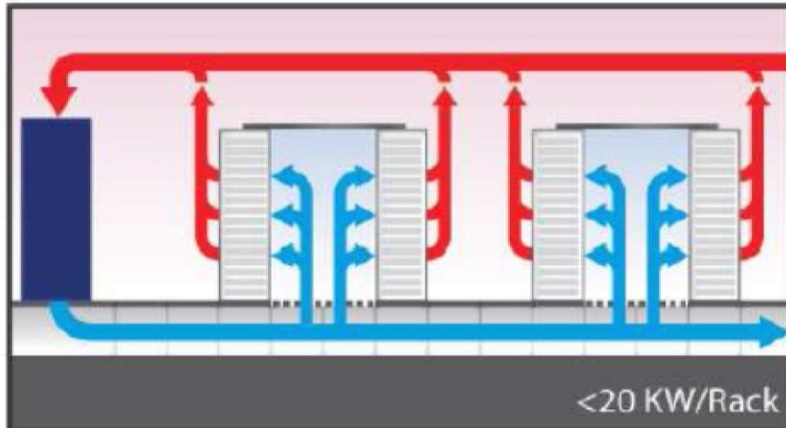

Air conditioning with water-cooled rack (sealed system)

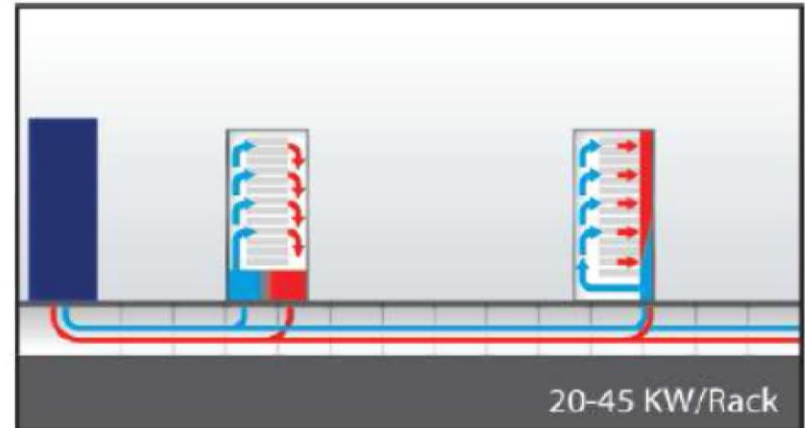

Air flow in the data center is essential for achieving optimal air conditioning. The question is whether hot or cold aisles make sense economically and are energy-efficient.

In a cold aisle system, cold air flows through the raised floor. The aisle between server cabinets is housed to be airtight. Since the floor is only opened up in this encapsulated area, cold air only flows in here. Data center operators therefore often provide this inlet with higher pressure. Nevertheless, the excess pressure should be moderate, since the fans in the server regulate air volume automatically. These are fine points, but they contribute greatly to optimizing the PUE value.

Computers blow waste heat into the remaining space. It rises upwards and forms a cushion of warm air under the ceiling. The closed-circuit cooling units suck out the air again, cool it and draw it back over the raised floor into the cold aisle between the racks. This way warm and cold air does not mix together and unnecessary losses or higher cooling requirements are avoided.

Datacentre's-Site Selection for Mission Critical Facilities

- When selecting a new site or evaluating an existing site, there are many risks and benefits that must be considered in order to optimize availability and reduce cost.
- Geographic and regional, local and site-related, and building risks need to be understood and mitigated to lessen the downtime effects on your business.
- Meanwhile, site selection can offer financial benefits when a data center considers climate, electricity rates, and incentives.

Datacentre's-Site Selection for Mission Critical Facilities

- Every site should consider the following general mitigation techniques to anticipate any emergency:
 1. Create emergency communication plans.
 2. Install a generator for emergency power in the event of an extended outage. Make sure you have several days' worth of fuel on hand.
 3. Add redundant utility feeds and/or carrier lines to help reduce the likelihood of the power going down. Redundant communication lines should be mandatory for those sites whose business relies on availability.

Datacentre's-Site Selection for Mission Critical Facilities

4. Be sure that the building is built at least to code and ideally higher than to code. That is probably the first basic defense against such storms.

It is recommended that the building meets similar standards required of fire and police stations, hospitals, and large gathering places.

5. Store food and water on site for a minimal staff for a week.

6. Have computer data backed up off site.

Dry flood proofing

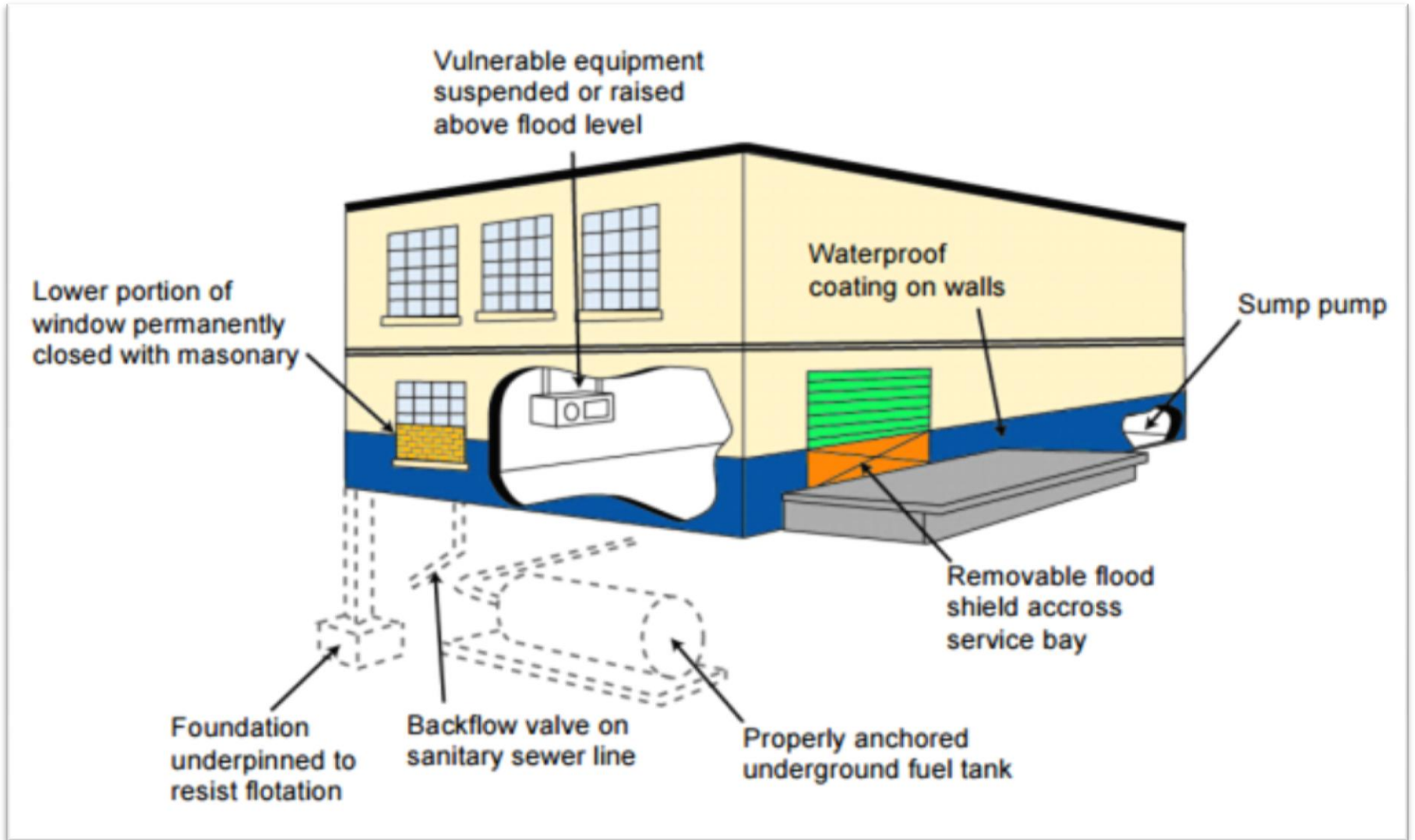

Fig. Dry flood proofing

Flood-resistant materials

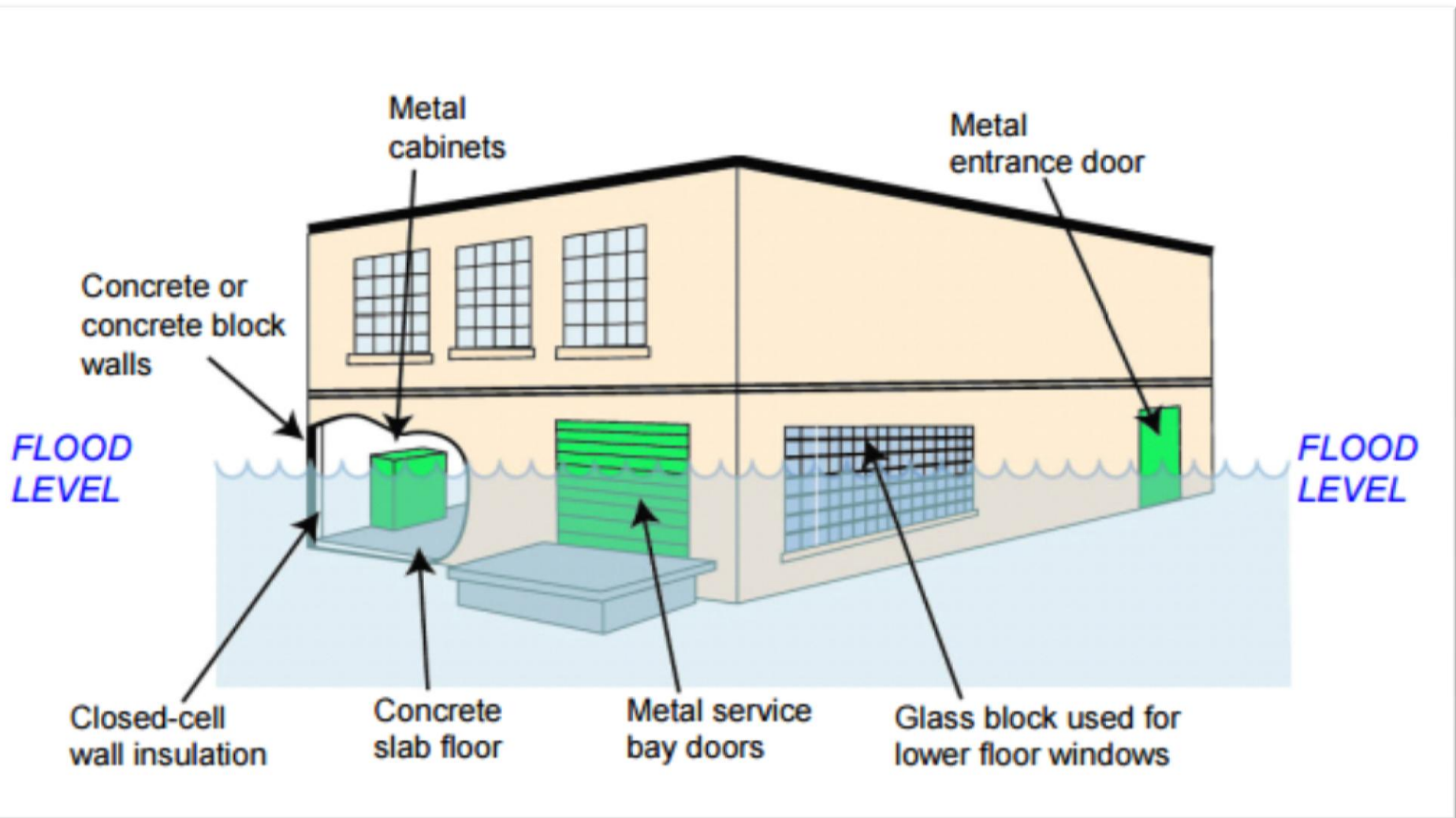

Fig. Flood-resistant materials

Design and Plan against Vandalism

- For most organizations, online data is one of their most expensive assets.
- All business-critical information is stored online and must be protected from sabotage, vandalism, and so forth. The data center must be selected in a building or neighbourhood where it is easy to control access.
- Check for existing doors, windows, or ventilators that open to the outside and uncontrolled areas.
- If they are not necessary, replace them with walls.

[Meaning->Action involving deliberate destruction of or damage to public or private property.]

Design and Plan against Vandalism

- If they are necessary, you must install alarm systems and motion detectors.
- However, it is best to locate the data center in the interior of a building so that it has no exterior doors or windows.
- When designing a new area, plan for one (or, at most, two) entrances to the data center.
- The design must include various monitoring devices. Install surveillance cameras at various locations, especially at entrances, such that they record the facial view of those entering the area.
- Motion detectors and alarms must be installed at various locations. If data-center space is shared with other companies, each company must have separate areas with physical barriers.

Design and Plan against Vandalism

- Make provisions for emergencies. Keep equipment-safe fire extinguishers at a few locations.
- You must protect the equipment and data not only from external intrusions but also from internal elements.
- Disgruntled employees are a common cause of vandalism.
- Only employees who need access must be granted it.
- Untrained personnel can create security risks, and they must be kept away from critical areas of the data center.

Best Practices

When designing a data center, plan ahead. New factors unfold and must be resolved before starting the construction phase. Keep the design simple. It is easy to set up and manage. Root causes of problems are easy to identify and resolve.

Following are some hints:

- *The design must be modular*—Use patch panels for Cat5 and fiber connections.
 - Segment the data center with sets and keep them independent
 - of each other. Each set must have its infrastructure equipment in a single
 - rack called the *point of distribution* (POD).
- *Label everything*—This includes ports, cable ends, and devices. Also,
 - label the physical grid locations in the data center. If the north-south
 - side is labeled with alphabets, the east-west side must be labeled as
 - numbers.

Best Practices

- *Document everything*—This includes device details, location, and software
 - components. Equipment location in the data center must be
 - documented online.

- *Isolate cables*—Keep all cable bundles either in the subfloor plenum or
 - ceiling plenum.

- *Use cast aluminum tiles*—They are strong and will be able to handle
 - increasing weights of future equipment and densely packed racks.

Data-Center Design Case Studies

For Case Study refer the Link

CASE STUDY

Appendix B. Acronym Key

CATV	community access television
DASD	direct-access storage device
HVAC	heating, ventilation and air conditioning
IDF	intermediate distribution frame
MDF	main distribution frame
PDU	power distribution units
RAF	raised-access floor
SRG	signal reference grid
UPS	uninterruptible power supply

References

1. <http://searchdatacenter.techtarget.com/definition/data-center>
2. https://en.wikipedia.org/wiki/Data_center
3. <http://www.webopedia.com/TERM/D/data-center.html>
4. Data Center Fundamentals- Cisco
5. Use Best Practices to Design Data Center Facilities-2005 Gartner
6. R&M Data Center Handbook Reichle & De-Massari AG